



538203-01

02

03

04

05

06

07

08

09

10

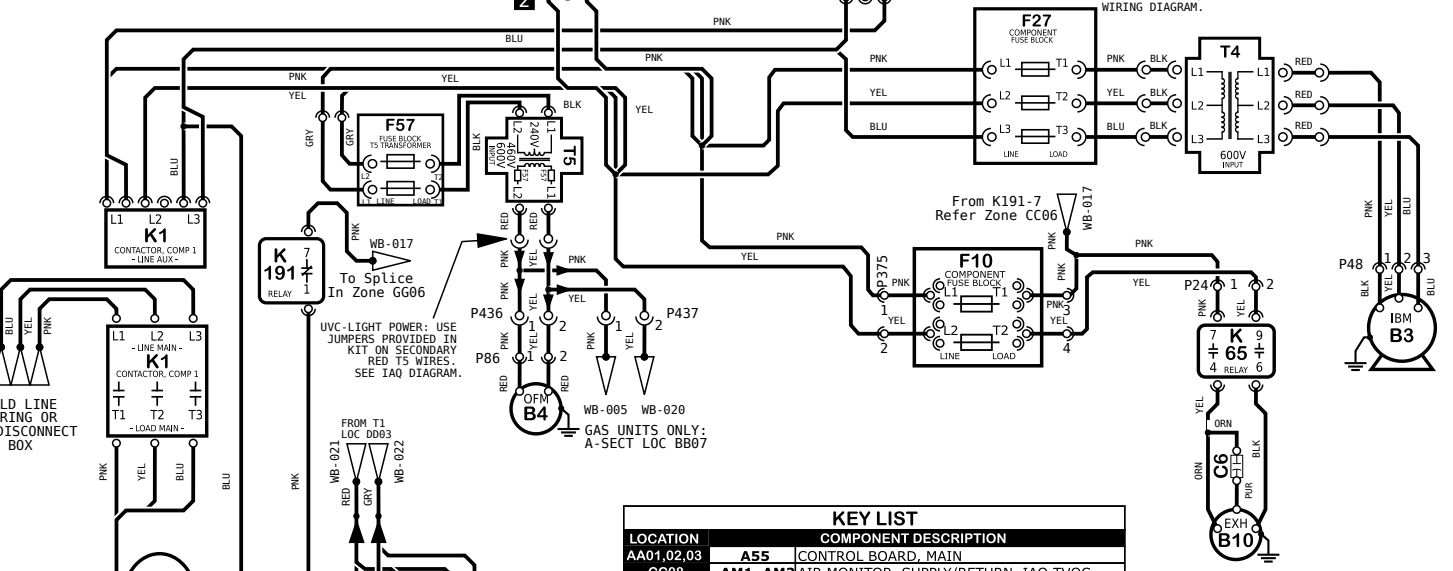
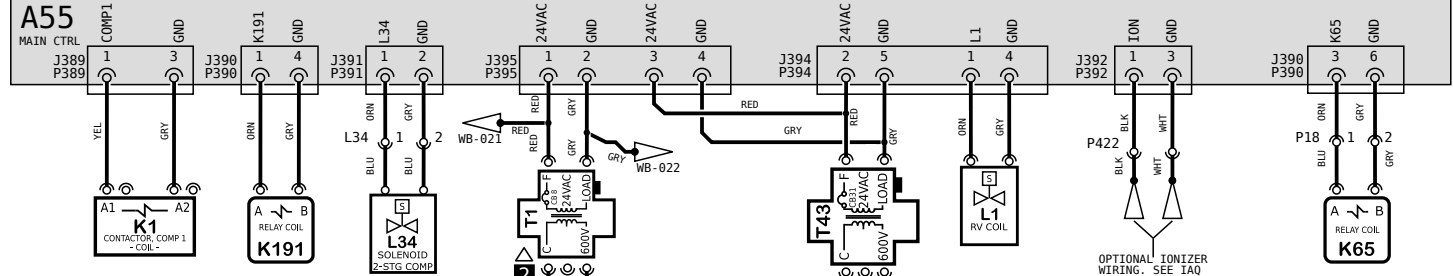
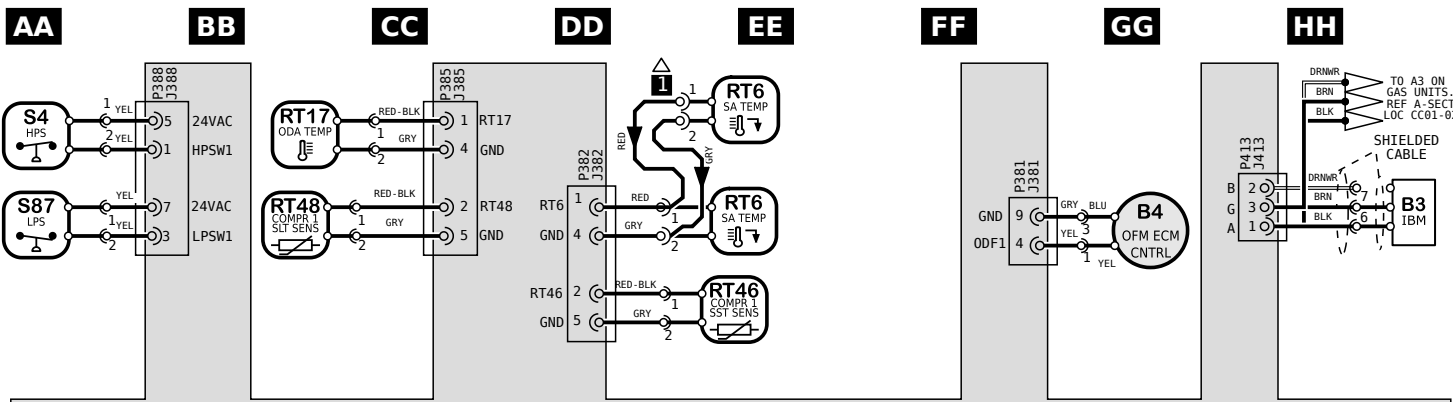

LOCATION	COMPONENT DESCRIPTION
AA01,02,03	A55 CONTROL BOARD, MAIN
CC08	AM1, AM2 AIR MONITOR, SUPPLY/RETURN, IAQ-TVOC
BB07	B1 COMPRESSOR 1
HH01,HH06	B3 MOTOR, BLOWER
GG02,DD06	B4 MOTOR, OUTDOOR FAN 1
HH06	B10 MOTOR, EXHAUST FAN 1
HH06	C6 CAPACITOR, EXHAUST FAN 1
FF06	F10 FUSE, COMPONENT
FF05	F27 FUSE, T4 TRANSFORMER PRIMARY
CC05	F57 FUSE, T5 TRANSFORMER PRIMARY
BB08	HR1 HEATER, COMPRESSOR 1
BB04,05,06	K1 CONTACTOR, COMPRESSOR 1
HH04,06	K65 RELAY, EXHAUST FAN 1
BB04,06	K191 RELAY, CRANKCASE HEATER 1
FF04	L1 VALVE, REVERSING 1
CC04	L34 VALVE, SOLENOID, 2 STG COMPRESSOR
EE01	RT6 SENSOR, A55 DISCHARGE (IMC)
CC01	RT17 SENSOR, OUTSIDE AIR TEMP
EE02	RT46 SENSOR, SAT. SUCT TEMP, COMP 1
CC02	RT48 SENSOR, SAT. LIQUID TEMP, COMP 1
AA01	S4 LIMIT, HI PRESS. SWITCH, COMP 1
AA01	S87 SWITCH, LOW PRESS., COMP 1
DD04	T1 TRANSFORMER, CONTROL
HH05	T4 TRANSFORMER, BLOWER
DD05	T5 TRANSFORMER, OUTDOOR FAN 1
EE04	T43 TRANSFORMER, REHEAT

NOTES	
1	RT6 REMOTE MOUNT WIRING
2	MOVE WIRES FROM 240 TO 208 TAP ON TRANSFORMER FOR 208 VOLT APPLICATIONS

Model: LDT, LHT 036H - 072H J VOLT HEATPUMP - EBM BLOWER WITH HIGHER SCCR
 Voltage: 575V/3~60Hz (J)
 Supersedes: N/A Form No: 538203-01 Rev: 2

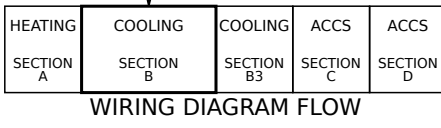

WARNING
 DISCONNECT ALL POWER BEFORE SERVICING.
 ELECTRIC SHOCK HAZARD, CAN CAUSE INJURY OR DEATH. UNIT MUST BE GROUNDED IN ACCORDANCE WITH NATIONAL AND LOCAL CODES.
 FOR USE WITH COPPER CONDUCTORS ONLY. REFER TO UNIT RATING PLATE FOR MINIMUM CIRCUIT AMPACITY AND MAXIMUM OVERCURRENT PROTECTION SIZE.
 IF ANY WIRE IN THIS APPLIANCE IS REPLACED, IT MUST BE REPLACED WITH WIRE OF LIKE SIZE, RATING AND INSULATION THICKNESS.

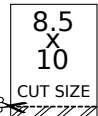

REV	EC NO.	DATE	BY	APVD	REVISION NOTE
--	CN-008852	06/01/2022	AXL	AAH	ORIGINATED AT PD&R CARROLLTON, TX
002	CN-012457P	3/26/2024	AXL	AAH	A) UPDATED MODEL DESC, WAS "036H-060H". UPDATED GROUND IMAGE ON B3/B4/B10



538203-01

02

03

04

05

06

07

08

09

10

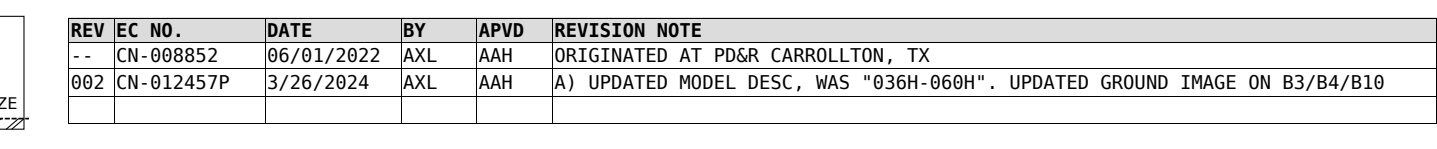
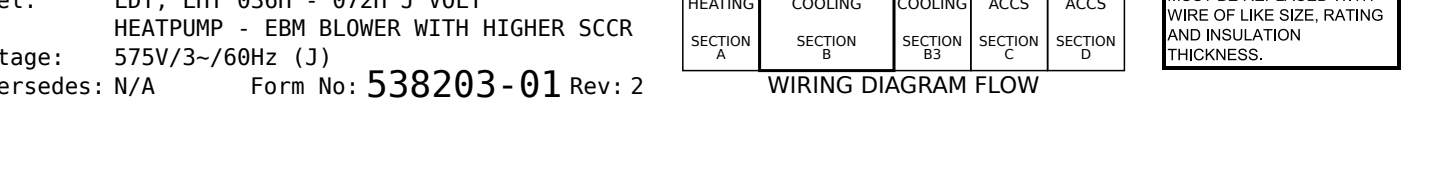
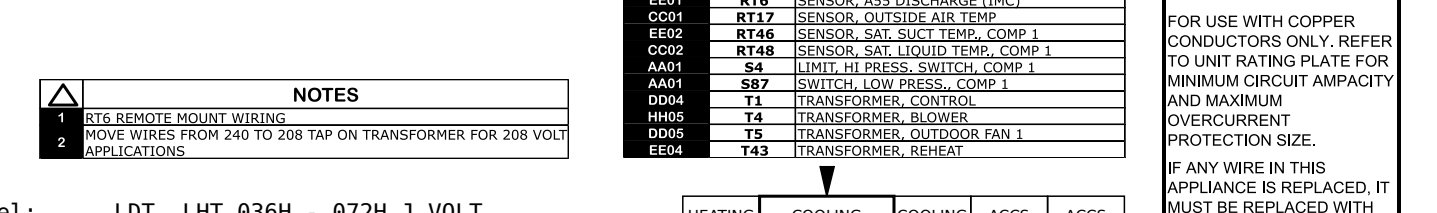
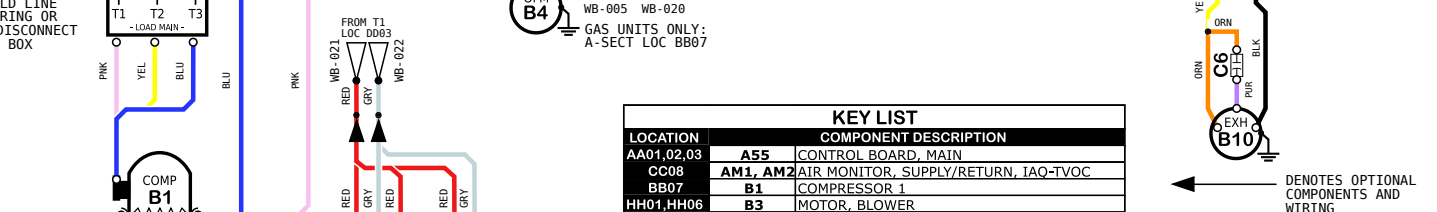
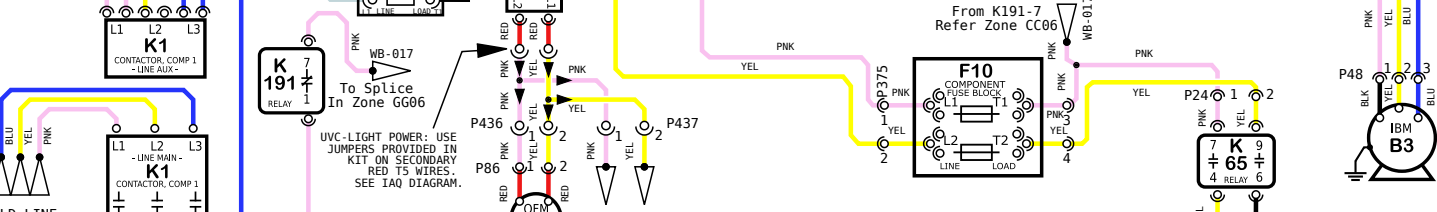
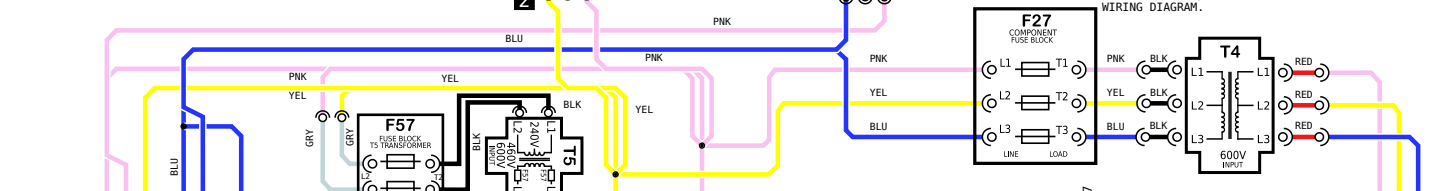
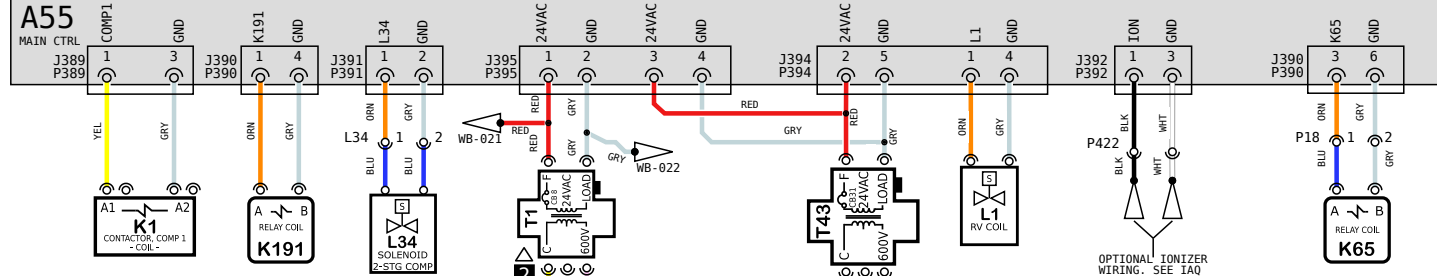
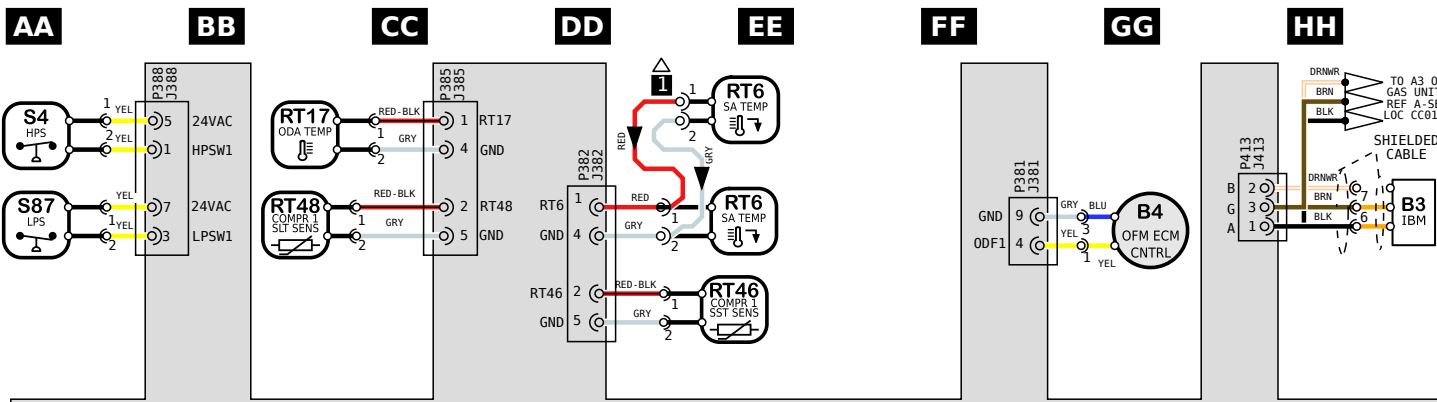

LOCATION	COMPONENT DESCRIPTION
AA01,02,03	A55 CONTROL BOARD, MAIN
CC08	AM1, AM2 AIR MONITOR, SUPPLY/RETURN, IAQ-TVOC
BB07	B1 COMPRESSOR 1
HH01,HH06	B3 MOTOR, BLOWER
GG02,DD06	B4 MOTOR, OUTDOOR FAN 1
HH06	B10 MOTOR, EXHAUST FAN 1
HH06	C6 CAPACITOR, EXHAUST FAN 1
FF06	F10 FUSE, COMPONENT
FF05	F27 FUSE, T4 TRANSFORMER PRIMARY
CC05	F57 FUSE, T5 TRANSFORMER PRIMARY
BB08	HR1 HEATER, COMPRESSOR 1
BB04,05,06	K1 CONTACTOR, COMPRESSOR 1
HH04,06	K65 RELAY, EXHAUST FAN 1
BB04,06	K191 RELAY, CRANKCASE HEATER 1
FF04	L1 VALVE, REVERSING 1
CC04	L34 VALVE, SOLENOID, 2 STG COMPRESSOR
EE01	RT6 SENSOR, A55 DISCHARGE (IMC)
CC01	RT17 SENSOR, OUTSIDE AIR TEMP
EE02	RT46 SENSOR, SAT. SUCT TEMP, COMP 1
CC02	RT48 SENSOR, SAT. LIQUID TEMP, COMP 1
AA01	S4 LIMIT, HI PRESS. SWITCH, COMP 1
AA01	S87 SWITCH, LOW PRESS., COMP 1
DD04	T1 TRANSFORMER, CONTROL
HH05	T4 TRANSFORMER, BLOWER
DD05	T5 TRANSFORMER, OUTDOOR FAN 1
EE04	T43 TRANSFORMER, REHEAT

NOTES	
1	RT6 REMOTE MOUNT WIRING
2	MOVE WIRES FROM 240 TO 208 TAP ON TRANSFORMER FOR 208 VOLT APPLICATIONS

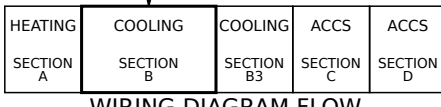

WARNING
DISCONNECT ALL POWER BEFORE SERVICING.
ELECTRIC SHOCK HAZARD, CAN CAUSE INJURY OR DEATH. UNIT MUST BE GROUNDED IN ACCORDANCE WITH NATIONAL AND LOCAL CODES.
FOR USE WITH COPPER CONDUCTORS ONLY. REFER TO UNIT RATING PLATE FOR MINIMUM CIRCUIT AMPACITY AND MAXIMUM OVERCURRENT PROTECTION SIZE.
IF ANY WIRE IN THIS APPLIANCE IS REPLACED, IT MUST BE REPLACED WITH WIRE OF LIKE SIZE, RATING AND INSULATION THICKNESS.

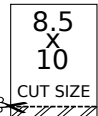

REV	EC NO.	DATE	BY	APVD	REVISION NOTE
--	CN-008852	06/01/2022	AXL	AAH	ORIGINATED AT PD&R CARROLLTON, TX
002	CN-012457P	3/26/2024	AXL	AAH	A) UPDATED MODEL DESC, WAS "036H-060H". UPDATED GROUND IMAGE ON B3/B4/B10