



©2016 Lennox Industries Inc.  
Dallas, Texas, USA



# INSTALLATION/ OPERATION INSTRUCTIONS

## V0STAT51P-2 Touch Screen Programmable Local Controller

### CONTROLS

507595-03

09/2016

#### General

The V0STAT51P-2 is a wired touch screen programmable local controller for VRF Heat Recovery and Heat Pump indoor units with convenient timed schedules for daily operation. These instructions are intended as a general guide and do not supersede local codes in any way. Consult authorities having jurisdiction before installation.

#### Requirements

Be sure that power supply has been turned off before beginning installation. This controller should be used only as described in this manual.

#### Shipping and Packing List

##### Package 1 of 1 contains;

- 1 – Wired Controller
- 1 – CR2032 Lithium battery
- 2 – Phillips screws
- 2 – Plastic spacers
- 2 – 1/8" polymer toggle anchors
- 1 – Installation and operation manual

#### Tools Needed

- #2 Phillips screwdriver
- Slotted precision screwdriver
- Level
- 1/8" wall anchor tools

#### Controller Placement

Avoid installing local controller in high load or heat loss areas such as exterior walls or walls that are against unconditioned spaces, near entry doors and windows, or where direct sunlight may be present.

### ⚠ WARNING

Improper installation, adjustment, alteration, service or maintenance can cause property damage, personal injury or loss of life.

Installation and service must be performed by a licensed professional HVAC installer (or equivalent) or service agency.

### IMPORTANT!

Frequent changes to operating mode may cause system malfunction. Allow at least one minute between mode changes to allow the system to stabilize.

### IMPORTANT!

Electrostatic discharge can affect electronic components. Take precautions to neutralize electrostatic charge by touching your hand and tools to metal prior to handling the control.

This manual must be left with the owner for future reference.

## Contents

General	1
Requirements	1
Shipping and Packing List	1
Tools Needed	1
Controller Placement	1
Installation	3
Connecting to One Indoor Unit	4
Connecting to Multiple Indoor Units	5
Mounting the Controller	6
Home Screen Display	8
Operation	10
Schedule Management	20
Create or Modify a Schedule	20
Copy and Paste a Schedule	25
Setup Holidays Schedule	27
Reset Weekly Timer Parameters	30
Override Function Settings	31
Error Code Display	33
Centralized Controller Lock Function	34
General Settings Configuration	36
Set Date	37
Set Time	38
Enable or Disable the Schedule Function	39
Set Daylight Savings Time	40
Set Home Screen Display Type	41
View and Edit Contractor and Controller Information	42
View Error Code History	43
Complete List of Error Code Descriptions	44
Service	45
Set System Type	46
Set Temperature Unit	47
Set Temperature Setpoint Range	48
Set Fan Control	49
Adjust Auxiliary / Alternative Heat Settings	50
Auxiliary Heat Settings	51
Alternative Heat Control	52
Lock Function	53
Change User Password for Service Configuration Access	54
Set Room Temperature Sensor Location	55
Set Room Temperature Sensor Calibration	56
Set Override Function	57
Set Louver Swing Function	58
Configure ERV Settings (Future Revision)	59
Advanced Information	60
Indoor Unit Operating Data	61
Indoor Unit Error Code History	63
HHE Relay Four Dry-Contact Status	64
Firmware and Setting Information	65
Copy/Change Settings or Update Firmware	66
Export Settings to USB	67
Import Settings from USB	68
Update Software	69
Software Update Best Practices	70
Reset Settings	71

## Installation

### **WARNING**

Be sure that power supply has been turned off before beginning installation. Do not operate controller with wet hands.

### **CAUTION**

Do not install controller in areas where harmful gases containing sulfur or other damaging agents may exist or the controller may be damaged.

Clean controller using a clean, damp cloth. Do not spray cleanser on or around controller.

### **IMPORTANT!**

Read all of the information in this manual before using this controller. All wiring must conform to local and national building and electrical codes and ordinances. This is a 12 VDC controller. Do not install on voltages higher than 12 VDC.

- This manual provides the installation instructions for this controller. Refer to the included wiring diagrams to connect the controller to the indoor unit.
- The controller uses low voltage. Keep a minimum distance of 12" (305 mm) between low voltage control wire and high voltage power wires.

#### **Power wiring between controller and first indoor unit:**

- Minimum 18 AWG stranded shielded cable up to 164 feet (50 m).
- Ensure there are no gaps between the controller back cover and the mounting surface.
- Fill any holes in the wall behind the controller to avoid false readings from infiltration.
- Ground the shielded control wiring.
- Do not use a megger to test insulation.

#### **Communication wiring between indoor units:**

- Minimum 18 AWG stranded shielded cable.

### Connecting to One Indoor Unit

Connect the controller to one indoor unit main control board using 4-conductor shielded cable. See figure 1.

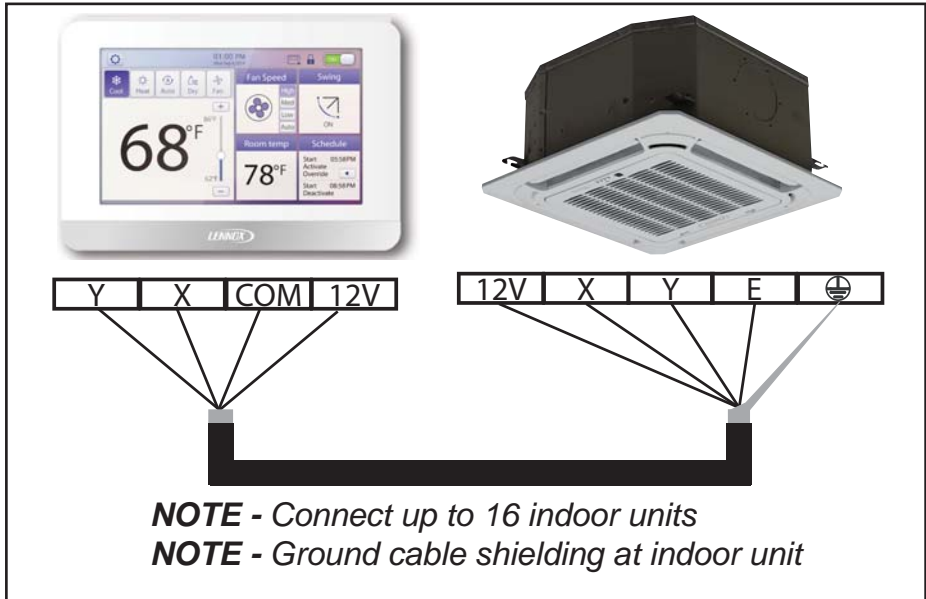
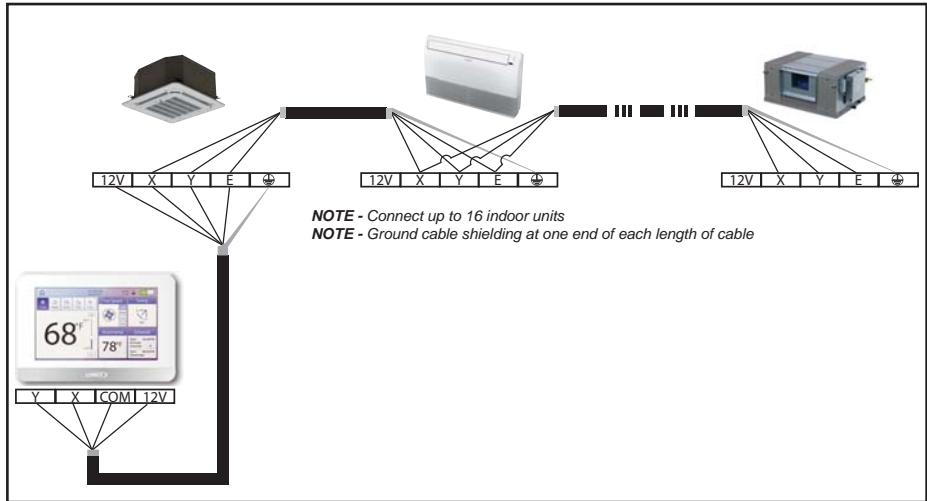

Figure 1. Connect Controller to Single Indoor Unit Wiring Connections

### Connecting to Multiple Indoor Units

Connect the controller to multiple indoor units, up to 16. Use 4-conductor shielded cable to connect to the first indoor unit, then daisy chain control wiring to each indoor unit using the XYE terminals in the electrical control box of the indoor unit. Do not daisy chain 12V power cable. See figure 2.

**NOTE** - All of the indoor units connected to the controller must be on the same refrigerant circuit, connected to the same outdoor unit.



**Figure 2. Connect Controller to Multiple Indoor Units Wiring Connections**

## Mounting the Controller

1. Remove the back cover from the controller. See figure 3.

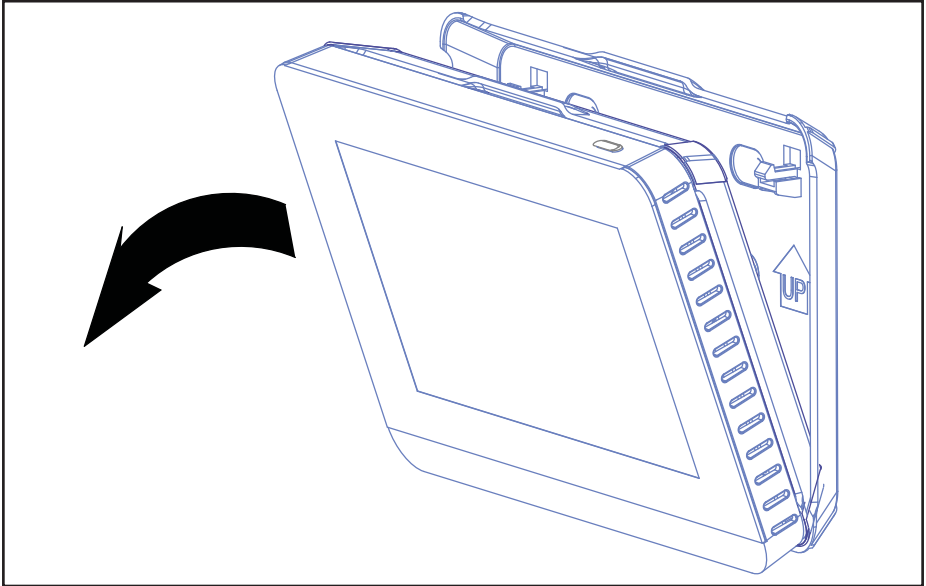

**Figure 3. Remove Back Cover from Controller**

2. Attach the back cover to the wall using screws. See figure 4.

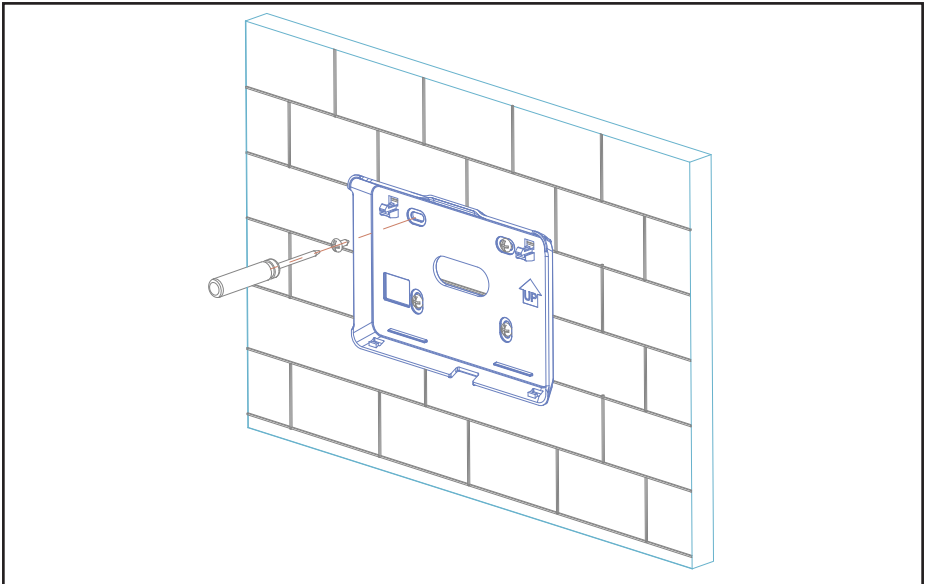

**Figure 4. Attach Back Cover to Wall**

3. Insert the controller into the bottom snap joints of the back cover at an angle. See figure 5.

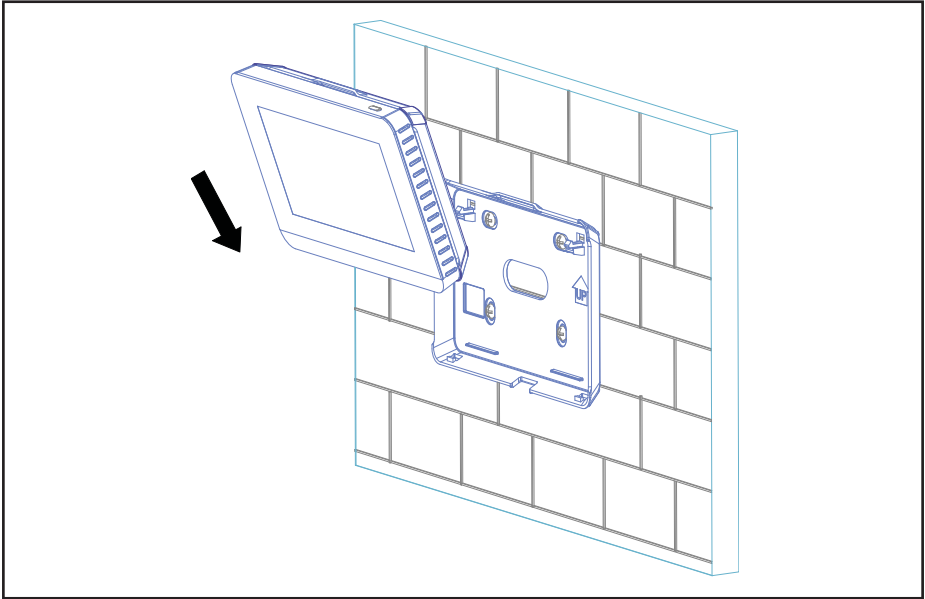

**Figure 5. Insert Controller into Back Cover**

4. Push the controller back toward the wall until it “snaps” into place. See figure 6.

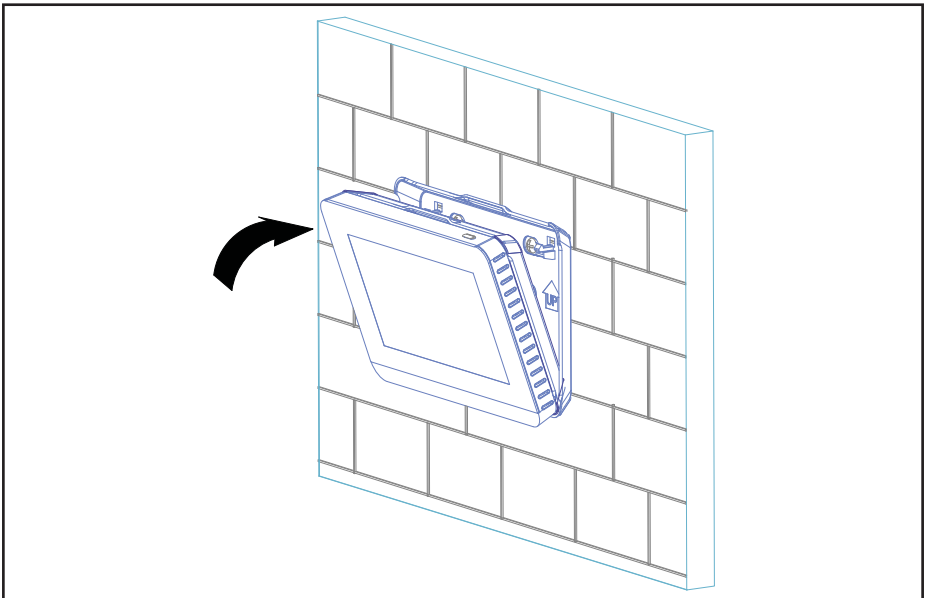

**Figure 6. Snap Controller Into Place**

# Home Screen Display

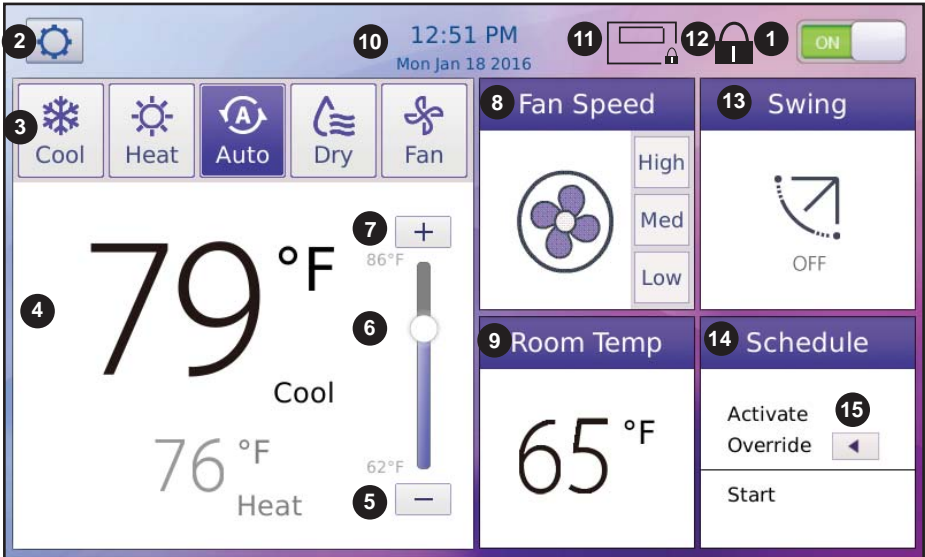

Figure 7. Standard Home Screen Display

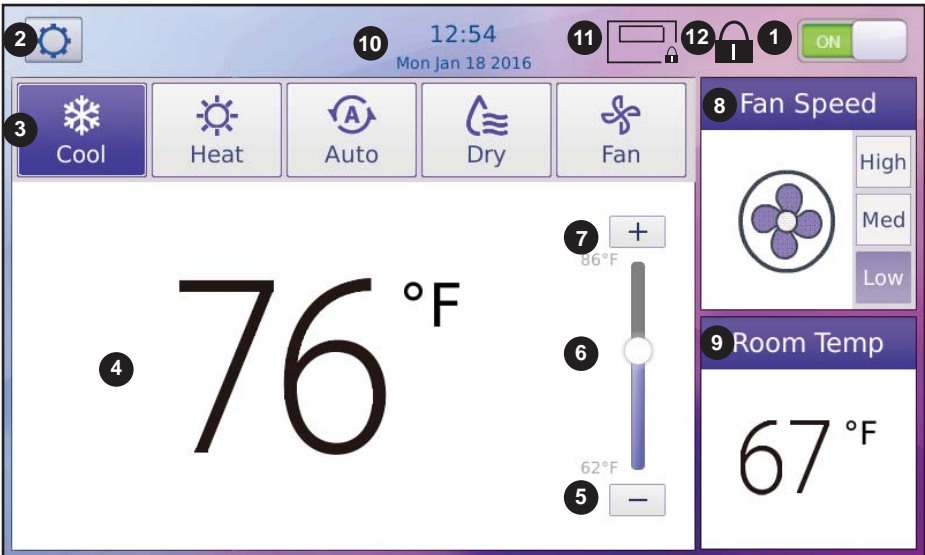

Figure 8. Simple Home Screen Display



**Table 1. Home Screen Display**

<b>Number</b>	<b>Display Item</b>	<b>Description</b>
1	ON/OFF button	Swipe to turn the indoor unit on or off.
2	Menu button	Tap to access the menu screen.
3	Mode buttons	Tap to switch the indoor unit operation mode.
4	Temperature	Displays the current setpoint setting.
5	Decrease button	Tap to lower the temperature setpoint.
6	Temperature slider	Drag to change the temperature setpoint.
7	Increase button	Tap to raise the temperature setpoint.
8	Fan speed	Tap High, Med, or Low to change the fan speed
9	Room temperature	Displays the room temperature.
10	Date/Time	Displays the current date and time
11	Centralized controller lock icon (not shown)	Indicates that the controller is locked by a central controller.
12	Lock icon (not shown)	Indicates that the selected function of the controller is locked.
13	Swing button	Tap to enable or disable the indoor unit automatic louver swing function. Not available on all indoor unit styles.
14	Schedule	Displays the schedule status. Tap to access weekly schedule settings.
15	Override	Displays the override status. Tap to access override settings.

## Operation

**NOTE** - Indoor units connected to a local controller may also be controlled by a centralized controller. Indoor units respond to the last command sent. It is recommended that indoor units be controlled from a single source of control, either local controller or centralized controller but not both, to avoid conflicts in commands.

**ON/OFF.** Swipe the On/Off slider to turn the indoor unit on or off.

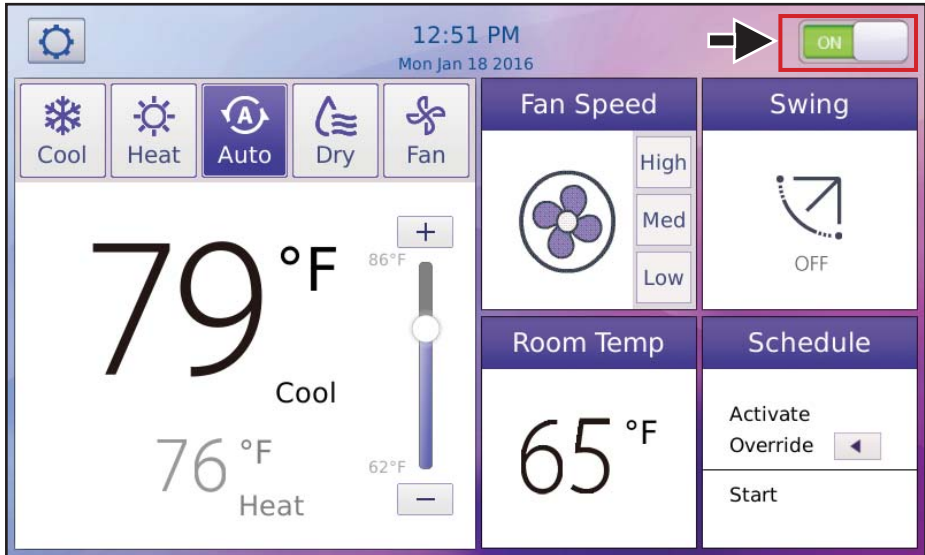

Figure 9. ON/OFF Operation

**Cooling Mode Operation.** Tap the Cool button to start cooling operation. The indoor unit will provide cooling operation to maintain the selected setpoint. The default setpoint range is 62°F to 86°F (17°C to 30°C).

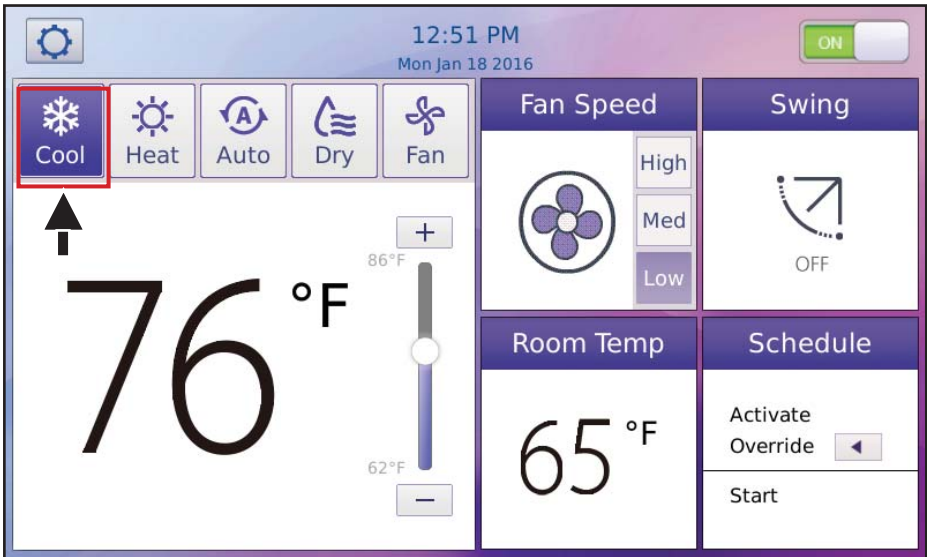

Figure 10. Cooling Mode Operation

**Heating Mode Operation.** Tap the Heat button to start heating operation. The indoor unit will provide heating operation to maintain the selected setpoint. The default setpoint range is 62°F to 86°F (17°C to 30°C).

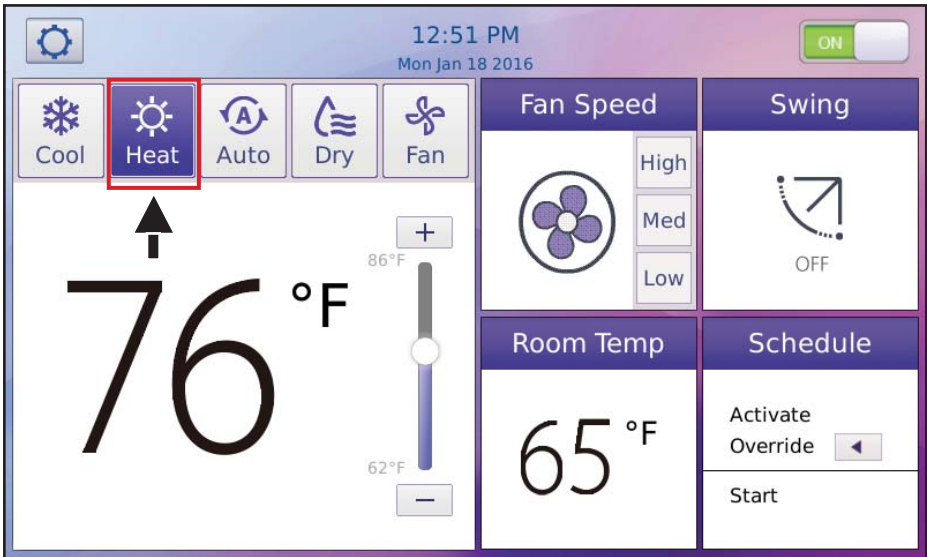

Figure 11. Heating Mode Operation

**Auto Mode Operation.** Only available on heat recovery systems. Tap the Auto button to start auto mode operation. The indoor unit will provide cooling or heating operation as determined by the room temperature and the setpoint settings. The setpoint range is 62°F to 86°F (17°C to 30°C). The cooling setpoint must be  $\geq 3^\circ$  higher than the heating setpoint.

**NOTE -** During Auto mode, both operation mode (cooling or heating) setpoints display on the Home screen. **The current operation mode setpoint displays larger than the non-current operation mode.**

To adjust the setpoint of either cooling or heating while in Auto mode, tap the appropriate setpoint, either cooling or heating. That setpoint will display as the larger number. Drag the temperature slider to the new setpoint temperature. If the setpoint you adjusted is not the current operation mode, after 10 seconds, the current operation mode setpoint will display as the larger number.

**NOTE -** A three degree setpoint deadband between cooling and heating setpoints is built in to the controller.

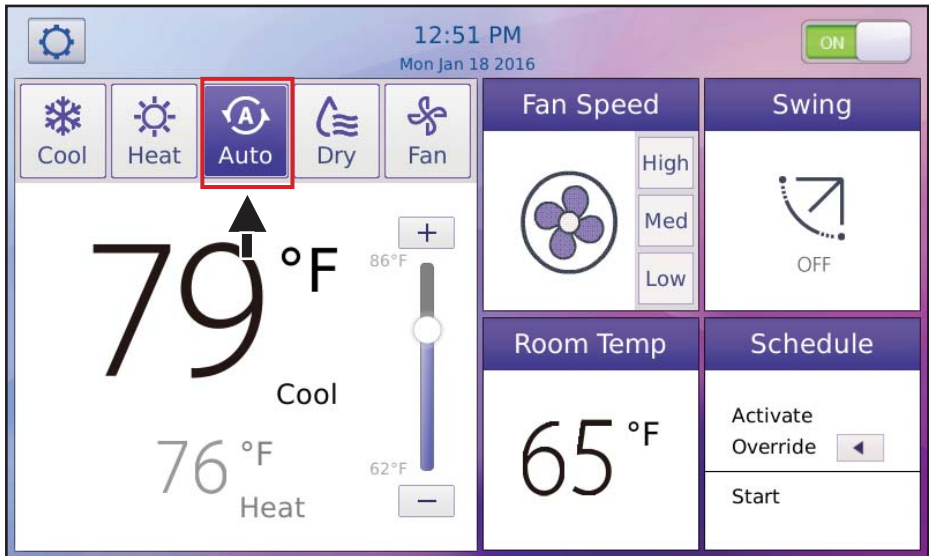

Figure 12. Auto Mode Operation

**Dry Mode Operation.** Tap the Dry button to start dry mode operation. Fan speed cannot be adjusted during dry mode.

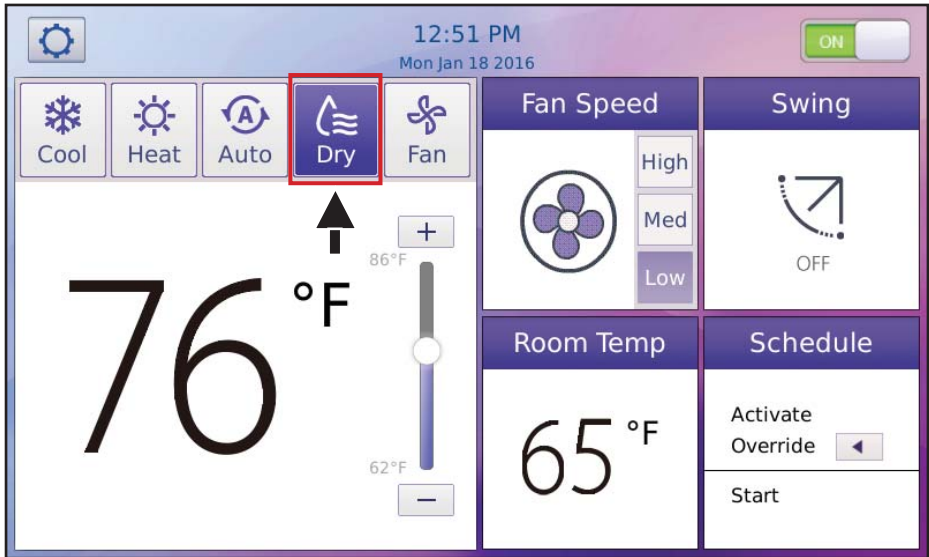

Figure 13. Dry Mode Operation

**Fan-Only Operation.** Tap the Fan button to start fan-only operation. The indoor unit fan operates without heating or cooling.

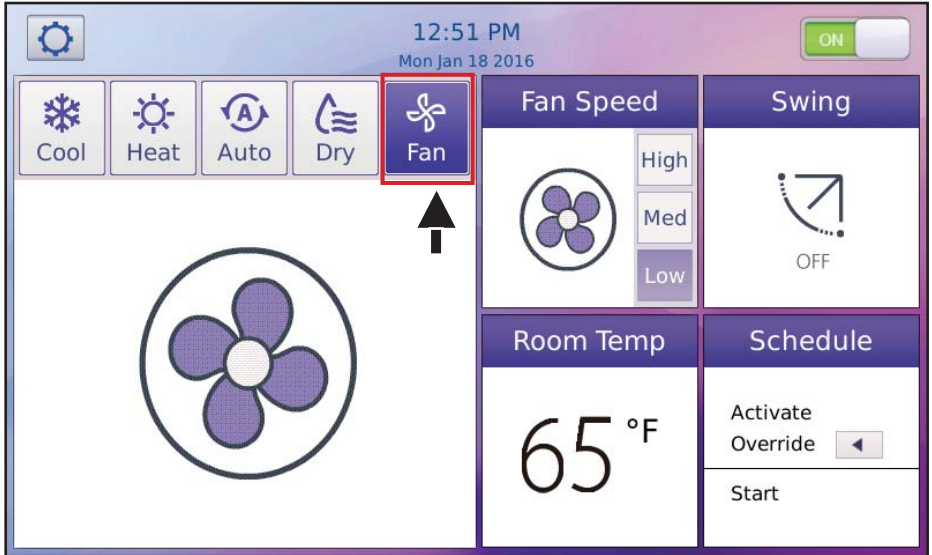
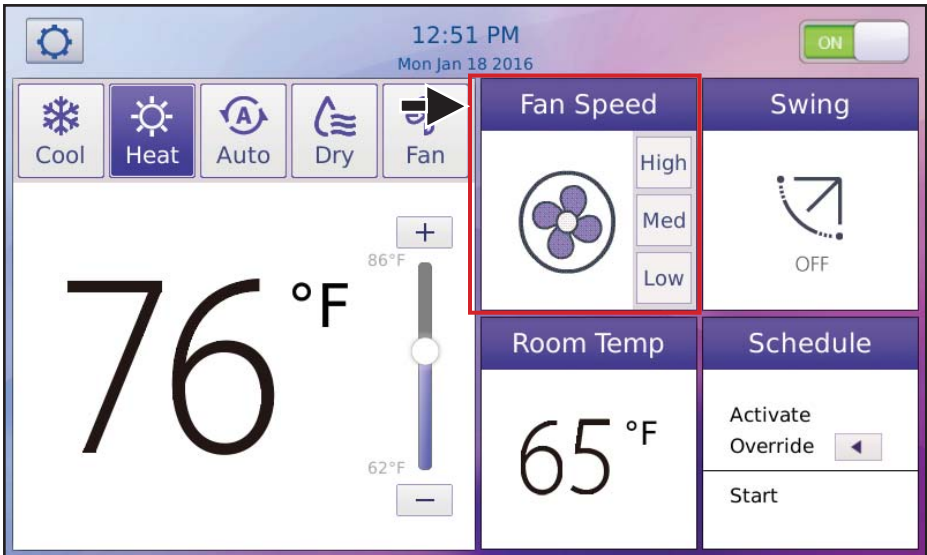

Figure 14. Fan-Only Mode Operation

**Fan Speed.** Tap High, Med, or Low to change the fan speed.



**Figure 15. Fan Speed Operation**



**Temperature Setpoint.** Adjust the setpoint of the current mode by dragging the temperature slider or by tapping the Increase (+) or Decrease (-) buttons. The default setpoint range is 62°F to 86°F (17°C to 30°C). The setpoint range can be adjusted using the Setpoint Limit screen in the Service menu.

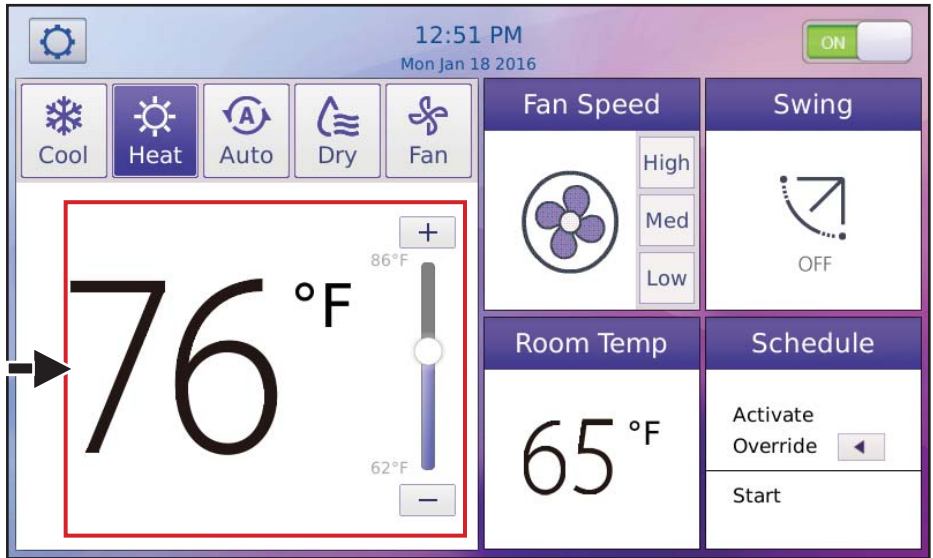

Figure 16. Temperature Setpoint

**Room Temperature.** The room temperature displays on the controller's main screen. The room temperature is sensed by the sensor inside the controller (default) or by the indoor unit. Set the sensor location using the Room Temperature Sensor Location screen in the Service menu.

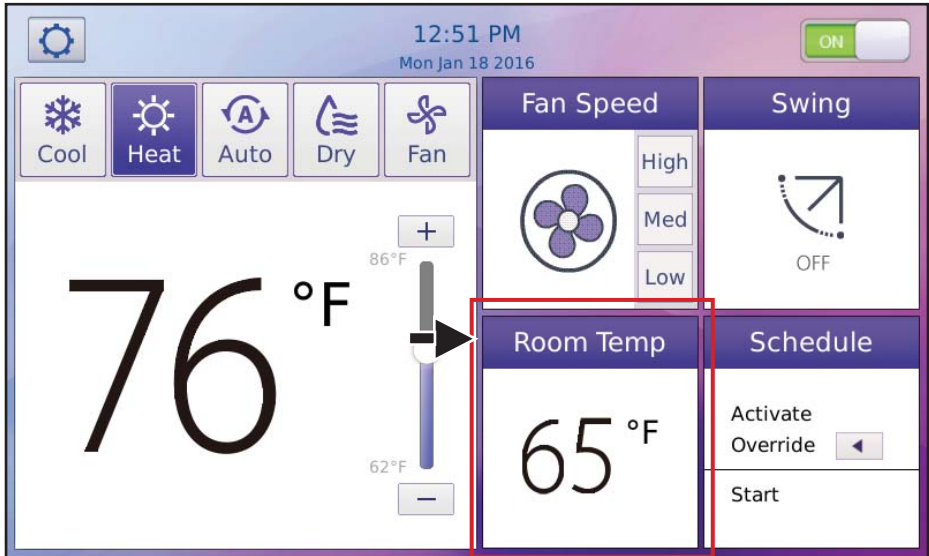

Figure 17. Room Temperature

**Swing.** Tap the Swing button to enable or disable the indoor unit automatic louver swing function. The swing icon changes to indicate if swing is on or off. Set the louver swing functionality using the Louver screen in the Service menu. (Not available for all indoor unit types.)

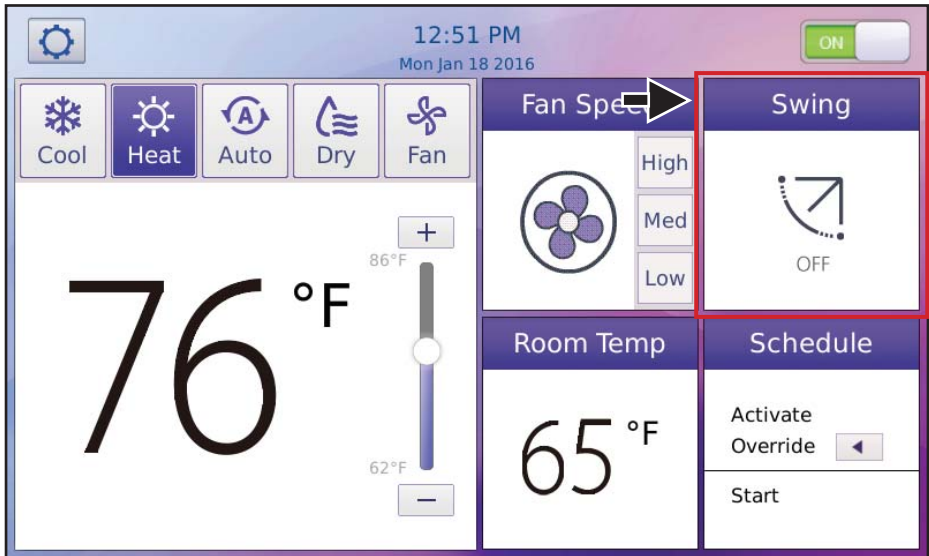

Figure 18. Swing

## Schedule Management

**NOTE** – If schedules are used and a centralized controller is installed on the system, controller functions should not be locked from the centralized controller.

### Create or Modify a Schedule

1. Tap the Schedule button to access the schedule program.

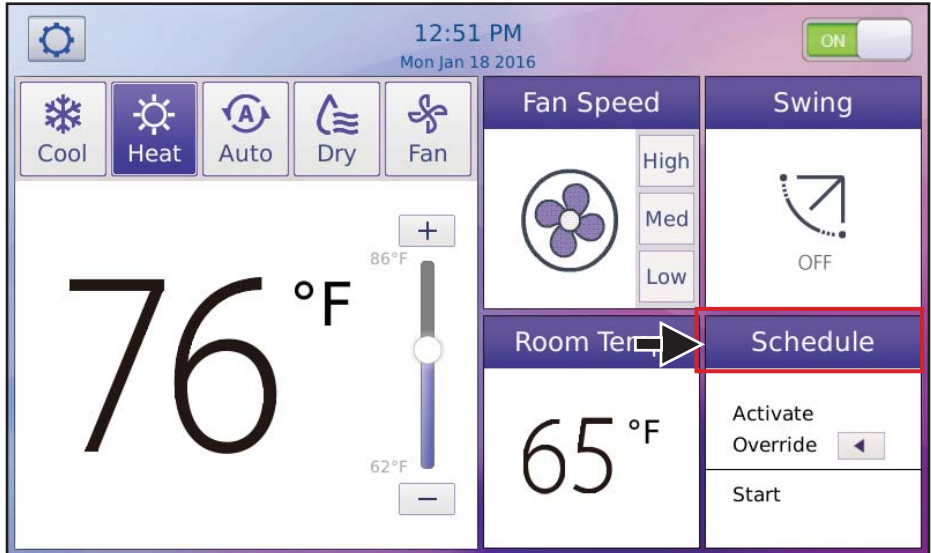
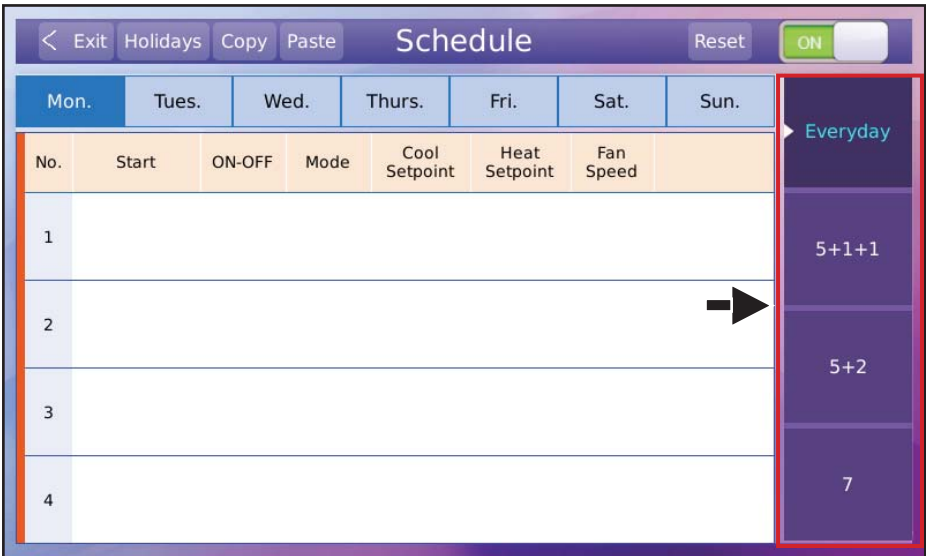

Figure 19. Tap Schedule Button to access Schedule Program

- Tap the button of the schedule type to setup or edit to select the schedule type. Only one option can be used. See Table 2 for descriptions.

**Table 2. Schedule Options**

Schedule	Description
Everyday	Set the schedule independently for each day of the week.
5+1+1	Set the schedule uniformly for Monday through Friday and independently for Saturday and Sunday.
5+2	Set the schedule uniformly for Monday through Friday and uniformly for Saturday and Sunday.
7	Set the schedule uniformly for each day of the week.



**Figure 20. Select Schedule Type**

3. Tap the blank space in the grid to set the first action. A set of default values will display.

The screenshot displays a 'Schedule' interface with a table of timer settings. The table has columns for No., Start, ON-OFF, Mode, Cool Setpoint, Heat Setpoint, and Fan Speed. The first row is highlighted with a red border and contains the following data: No. 1, Start 08:00 AM, ON-OFF ON, Mode Auto, Cool Setpoint 79°F, Heat Setpoint 76°F, and Fan Speed Low. To the right of the table are buttons for 'Delete' and 'Edit'. Below the first row, an arrow points to the empty space in the grid. The right sidebar shows options: 'Everyday', '5+1+1', '5+2', and '7'. The top navigation bar includes '< Exit', 'Holidays', 'Copy', 'Paste', 'Schedule', 'Reset', and an 'ON' toggle switch.

No.	Start	ON-OFF	Mode	Cool Setpoint	Heat Setpoint	Fan Speed	
1	08:00 AM	ON	Auto	79°F	76°F	Low	Delete Edit
2							
3							
4							

Figure 21. Display Timer Information

4. Tap the Edit button.

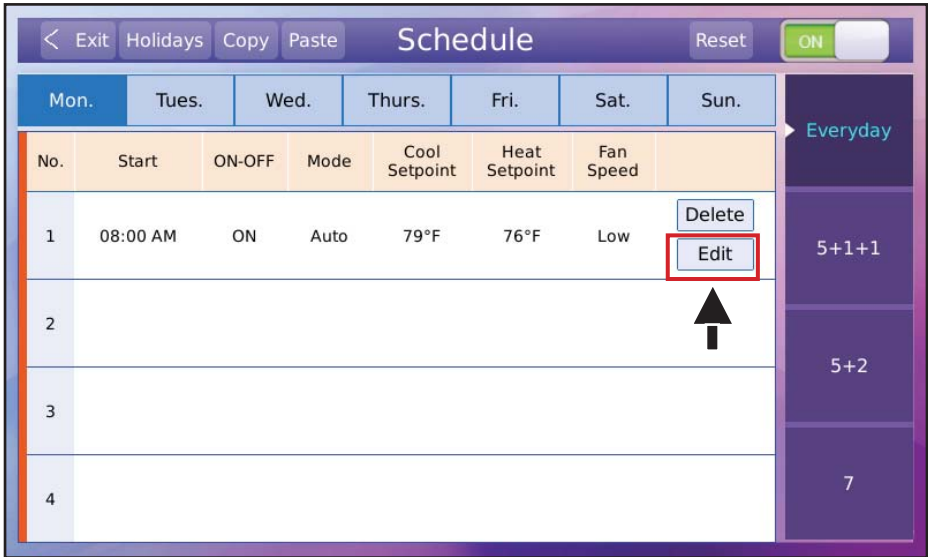

Figure 22. Tap Edit Button

5. Set or modify the event parameters including the action begin time, ON/OFF, mode, cooling temperature setting, heating temperature setting, and fan speed.
6. Tap the OK button to save the settings.
7. Tap the Delete button to delete the action.

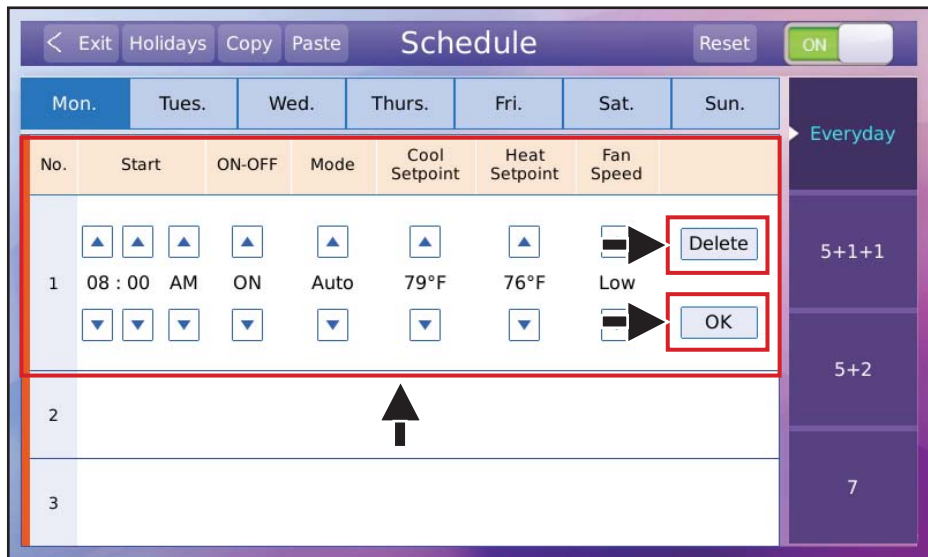

Figure 23. Adjust Event Settings

8. Up to 8 timer actions/events can be scheduled for each day.

The screenshot displays a 'Schedule' interface with a top navigation bar containing '< Exit', 'Holidays', 'Copy', 'Paste', 'Schedule', 'Reset', and an 'ON' indicator. Below the navigation bar is a table with columns for days of the week (Mon., Tues., Wed., Thurs., Fri., Sat., Sun.). The main table lists timer actions with the following columns: No., Start, ON-OFF, Mode, Cool Setpoint, Heat Setpoint, Fan Speed, and buttons for Delete and Edit. A right-hand sidebar shows a weekly schedule summary with the following entries: Everyday, 5+1+1, 5+2, and 7.

Mon.	Tues.	Wed.	Thurs.	Fri.	Sat.	Sun.	
No.	Start	ON-OFF	Mode	Cool Setpoint	Heat Setpoint	Fan Speed	
2	11:30 AM	ON	Auto	76°F	73°F	Med	Delete Edit
3	04:00 PM	ON	Auto	78°F	75°F	Low	Delete Edit
4	08:00 PM	ON	Auto	80°F	76°F	Low	Delete Edit
5							

Everyday  
5+1+1  
5+2  
7

Figure 24. Edit Schedule Actions/Events



### Copy and Paste a Schedule

1. Select the day you want to copy and tap the Copy button. A red triangle displays on the day that is selected for copying.

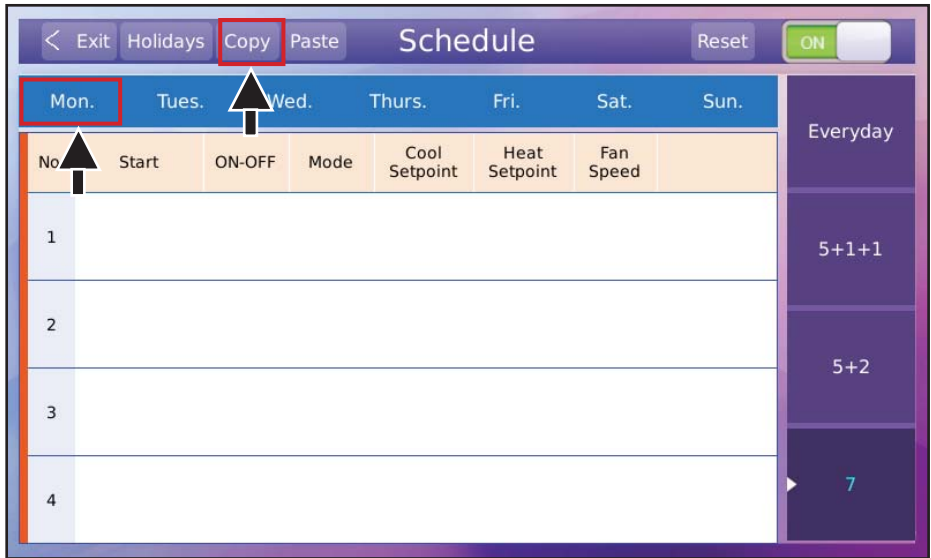

Figure 25. Select Day to Copy From

2. Select the day to copy to and tap the Paste button.

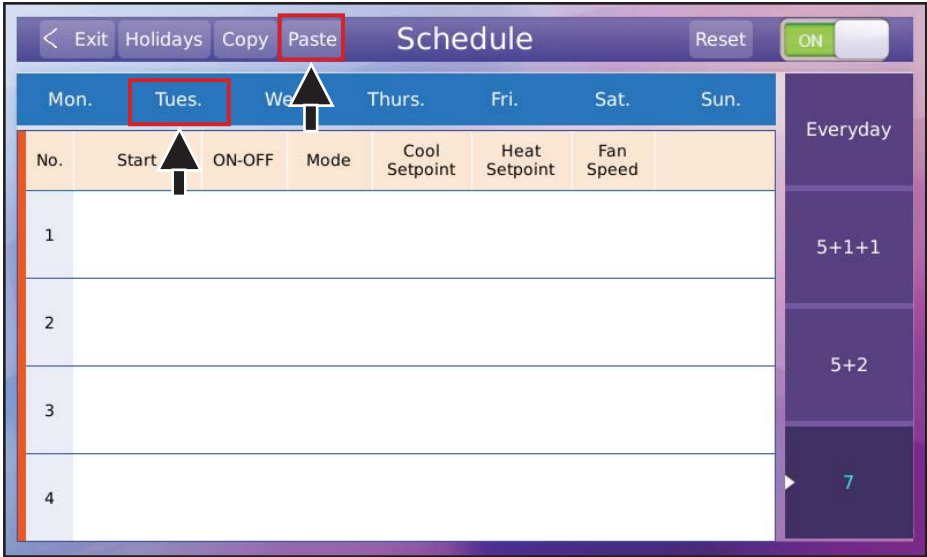

Figure 26. Select Day to Copy To

### Setup Holidays Schedule

Holiday scheduling overrides the set schedule settings on those days.

1. Tap the Holidays button to access the holiday schedule settings.

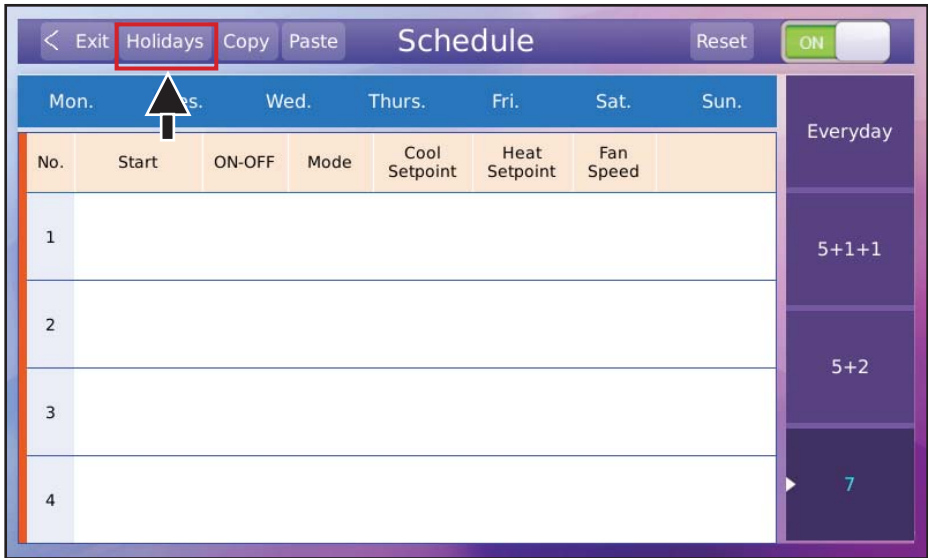

Figure 27. Setup Holidays Schedule

2. Tap the blank space in the grid and then tap the Edit button.

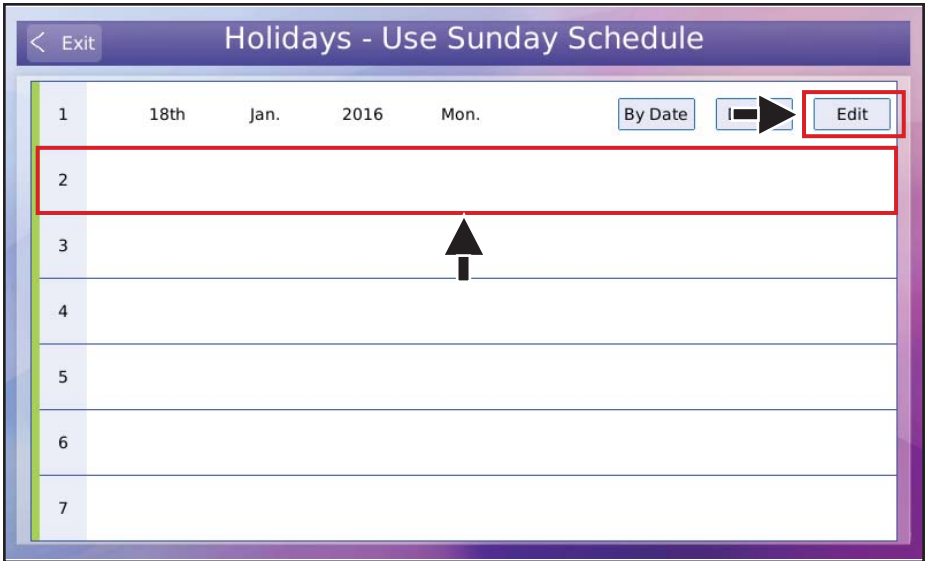
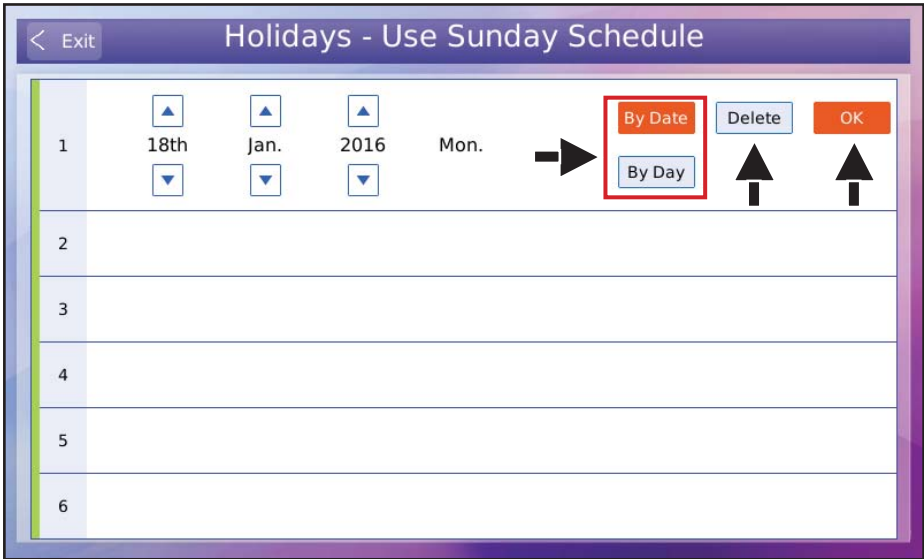

Figure 28. Edit Holiday Schedule

3. Tap the By Date button to select the holiday by specific year, month and day. (Ex: 18th January 2016)
4. Select the By Day button to select the holiday by month and week. (Ex: 3rd Monday in January)



**Figure 29. Save Holidays Schedule Parameters**

5. Tap the OK button to save the holiday schedule settings.
6. Tap the Delete button to delete the active holiday schedule.

### Reset Weekly Timer Parameters

1. Tap the Reset button to permanently delete all schedules. This cannot be undone.

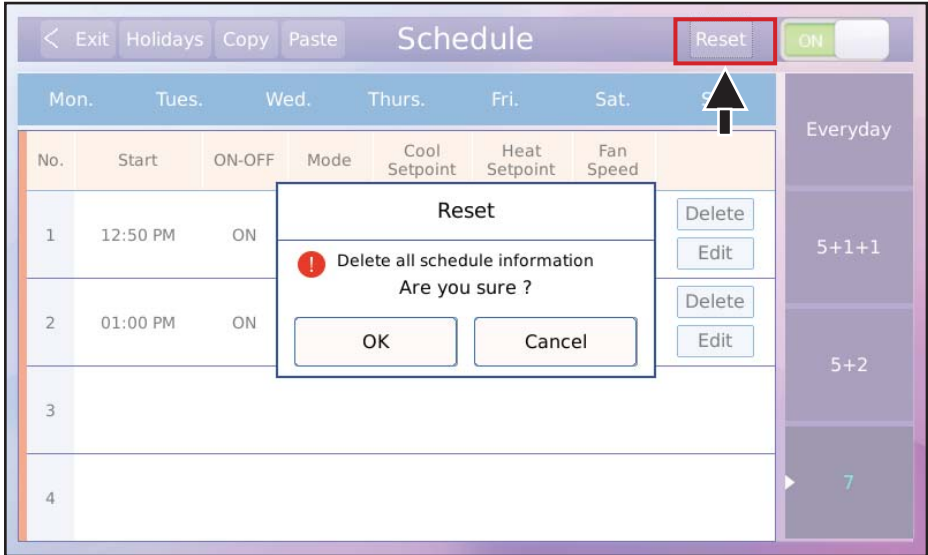

Figure 30. Reset Schedule

### Override Function Settings

Use the override function to override the current schedule for a set period of time. At the end of the override time period, system operation returns to the scheduled operation. Override is only available when a schedule has been set.

1. Tap the Activate Override button to access the override timer menu.

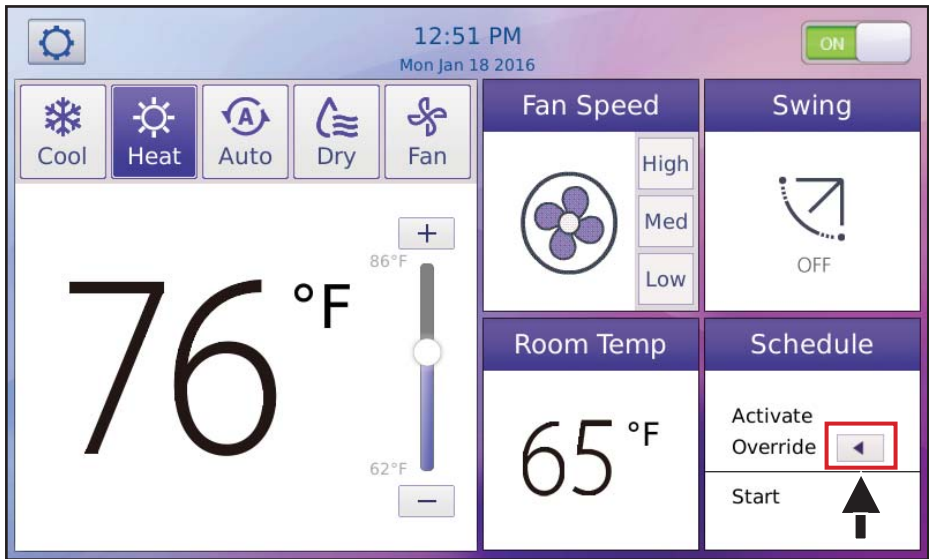

Figure 31. Override Schedule

2. Select the amount of time for the override. Options are 30, 60, 90 or 120 minutes.
3. To hide the time period buttons, tap the Override button again or wait 5 seconds.

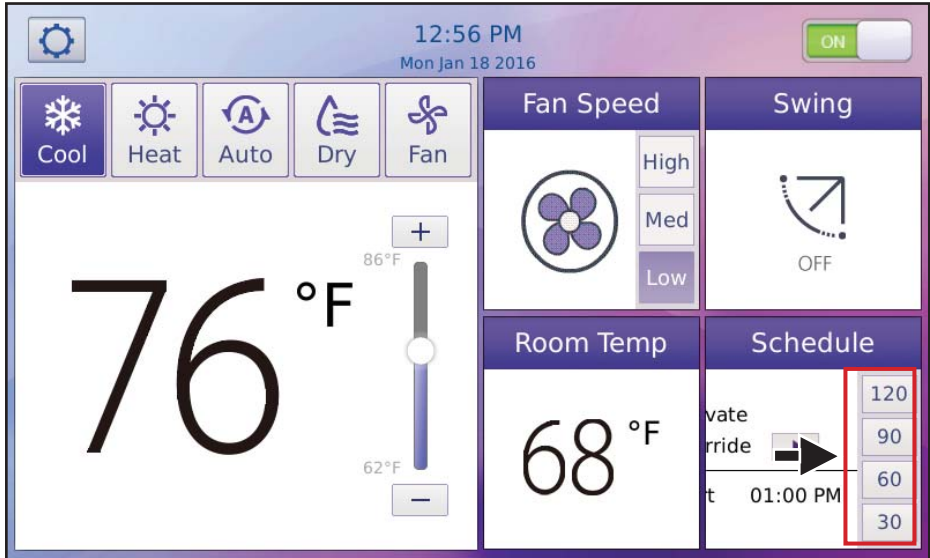

Figure 32. Override Time Period



## Error Code Display

- The controller will display only error codes of connected indoor units.
- When an indoor unit has an error code, the temperature setpoint display will be replaced by the indoor unit address and error code.
- If multiple indoor units have errors occur simultaneously, the codes will scroll on the home screen.
- If one indoor unit has multiple errors simultaneously, the controller will display only one error code.
- Access code history and descriptions by tapping the right-arrow button in the failure display area

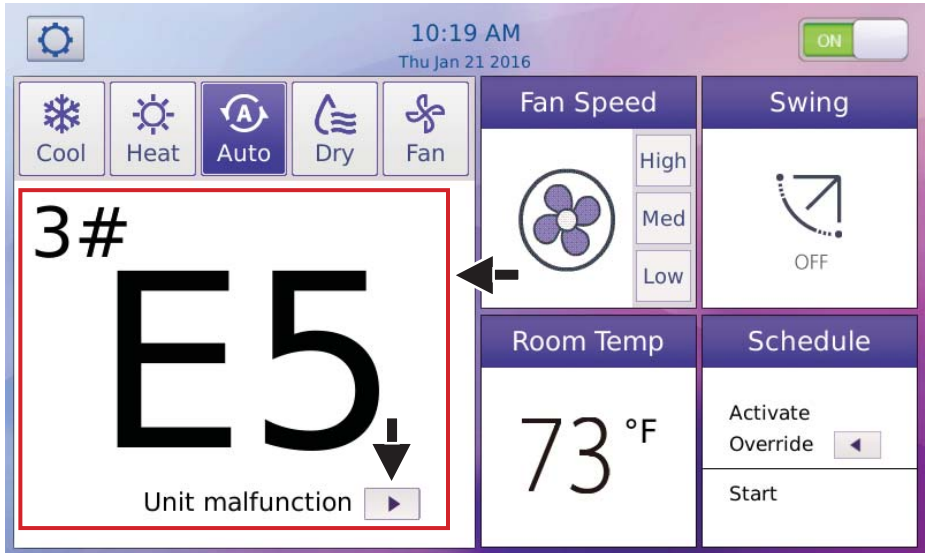

Figure 33. Error Code Display

## Centralized Controller Lock Function

- The local controller can be locked by a centralized controller.
- The centralized controller lock icon displays when the controller is being locked by the centralized controller.
- Functions locked by the centralized controller will be disabled.

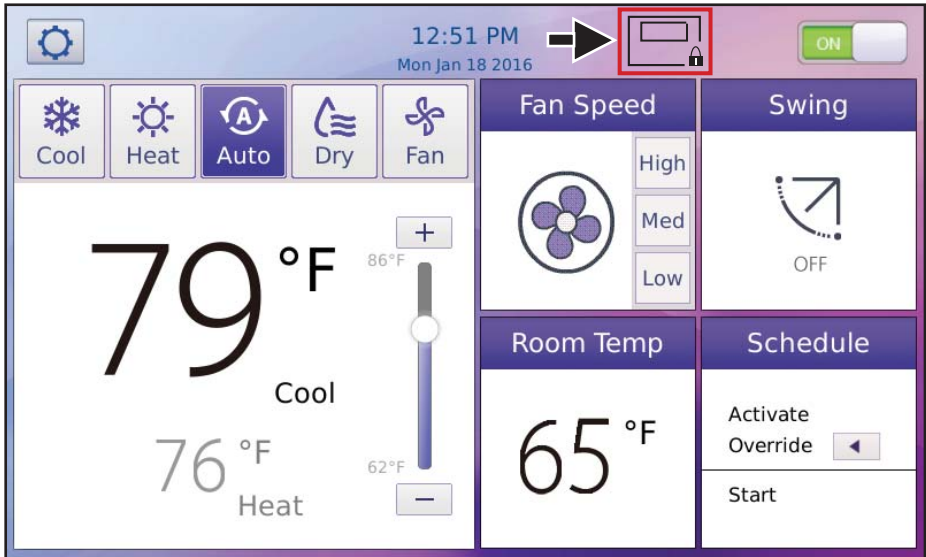

Figure 34. Locked by Centralized Controller

**Table 3. Centralized Controller Locks**

<b>Centralized Controller Locks</b>	<b>Description</b>
Remote control lock	Locks the ON/OFF mode, fan speed, setting temperature, and swing button actions of the controller.
ON lock	Locks the ON/OFF button action of the controller to be ON only.
OFF lock	Locks the ON/OFF button action of the controller to be OFF only.
Lock the lower limit of cooling set temperature	Locks the lower limit regulation action for the setpoint temperature in cooling/dehumidifying mode or the cooling setpoint temperature in auto mode on the controller.
Lock the upper limit of heating setting temperature	Locks the lower limit regulation action for the setpoint temperature in heating mode or the heating setpoint temperature in auto mode on the controller.
Mode lock	Locks the operation mode button action of the controller.
Fan speed lock	Locks the fan speed button action of the controller.

## General Settings Configuration

- Access the settings menu by tapping the Menu button (gear icon) on the Home screen.

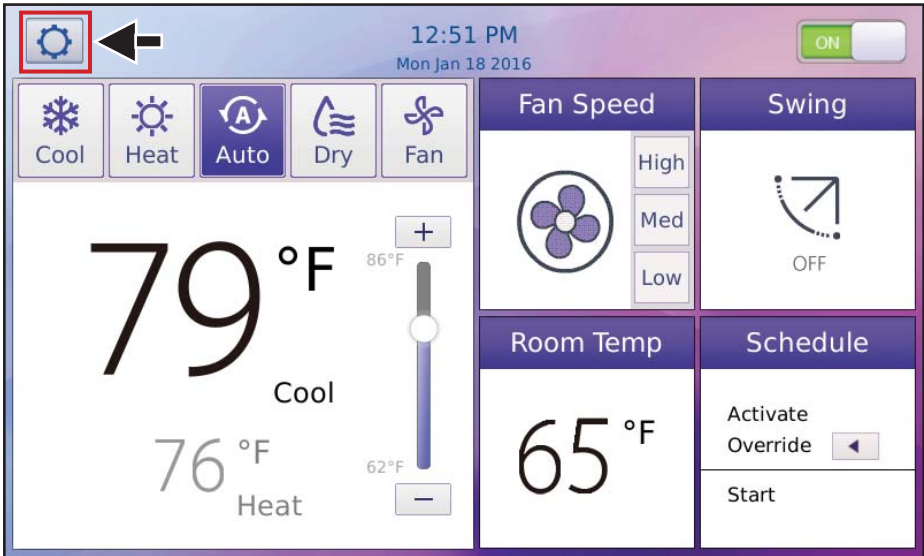

Figure 35. Access Settings Menu

### Set Date

Set the date that is displayed on the controller screen.

1. Tap the Menu button on the Home screen and then tap the Date button.
2. Use the up-arrows and down-arrows to set the date.
3. Tap the Save button to save the setting.

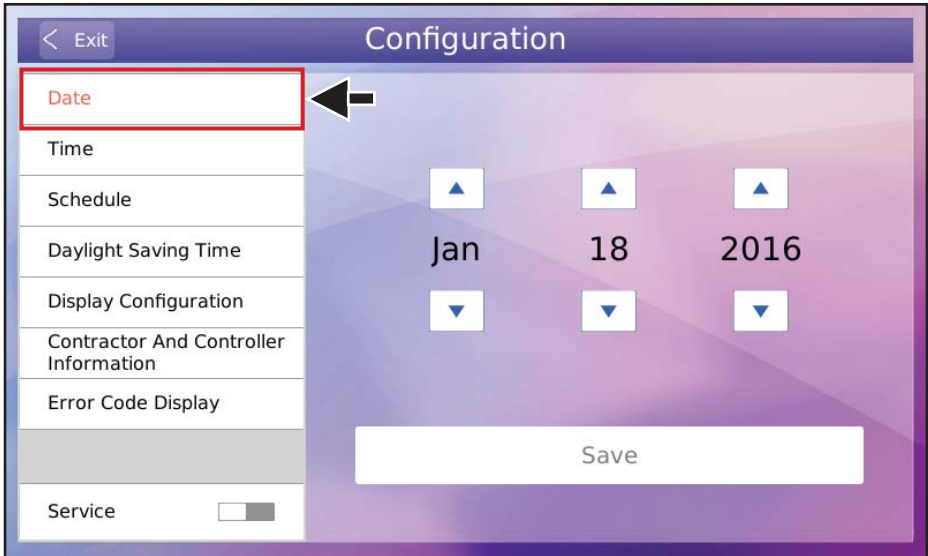

Figure 36. Set Date

## Set Time

Set the time that is displayed on the controller screen.

1. Tap the Menu button on the Home screen and then tap the Time button.
2. Time is displayed in 12-hour format by default.
3. Tap the Use 24-hour format checkbox to display 24-hour time.
4. Tap the Save button to save the settings.

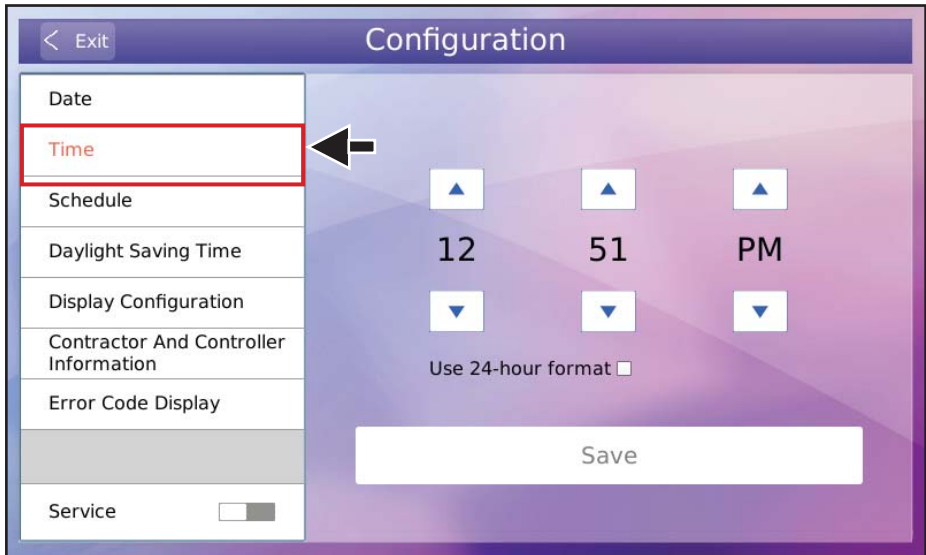

Figure 37. Set Time 12-Hour Clock

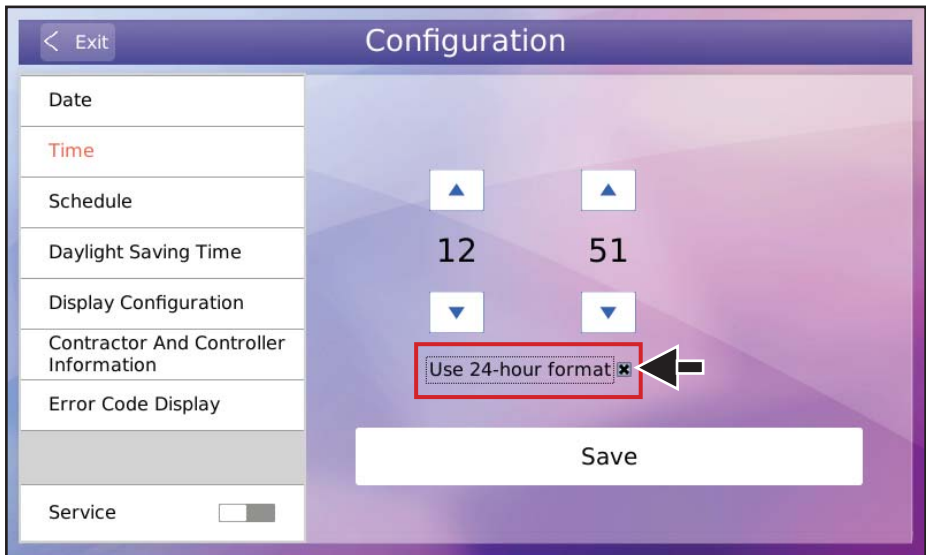

Figure 38. Set Time 24-Hour Clock

### Enable or Disable the Schedule Function

Enable or disable the schedule function.

1. Tap the Menu button on the Home screen and then tap the Schedule button.
2. Tap the Schedule Enable button to enable the schedule function.
3. Tap the Schedule Disable button to disable the schedule function.
4. Tap the Set Schedule button to access the Schedule Management screen.

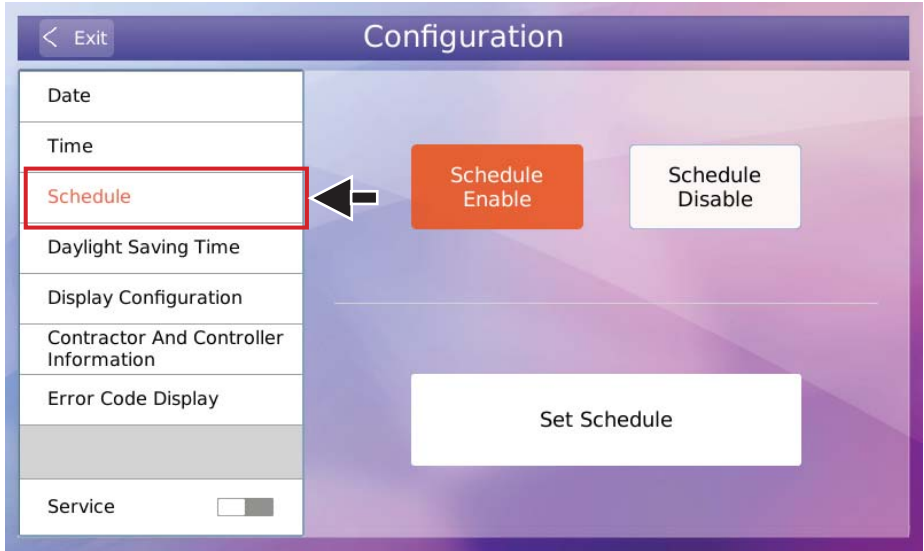

Figure 39. Set the Schedule Function

### Set Daylight Savings Time

Enable or disable daylight savings time function.

1. Tap the Menu button on the Home screen and then tap the Daylight Saving Time button.
2. Tap the Enable button to enable daylight savings time function.
3. Tap the Disable button to disable daylight savings time function.

**NOTE** - The 2nd Sunday in March, the clock is set forward 1 hour. The 1st Sunday in November, the clock is set back 1 hour.

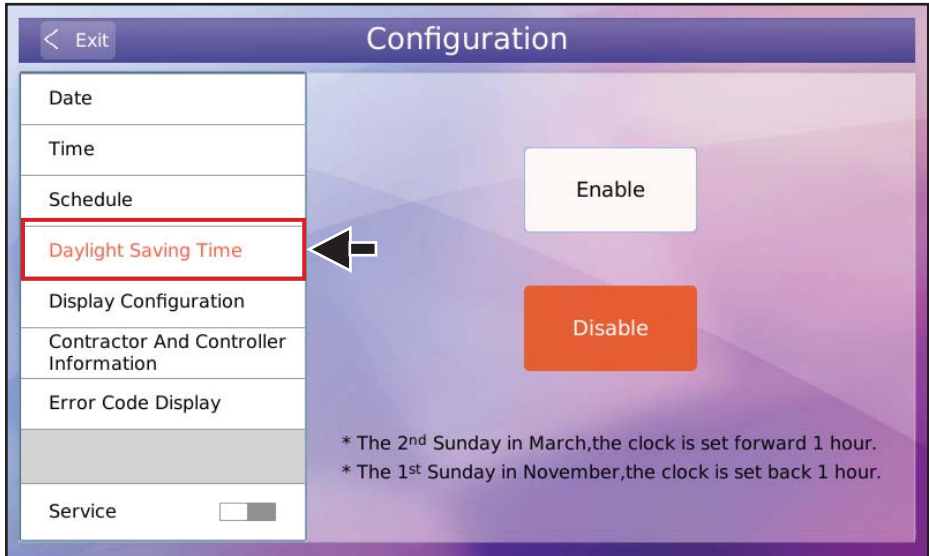

Figure 40. Set Daylight Savings Time



### Set Home Screen Display Type

Select the Home screen display type.

1. Tap the Menu button on the Home screen and then tap the Display Menu button on the Home screen.
2. Tap the Simple Display button to enable simple display mode. Only displays frequently used functions.
3. Tap the Standard Display button to enable standard display mode.

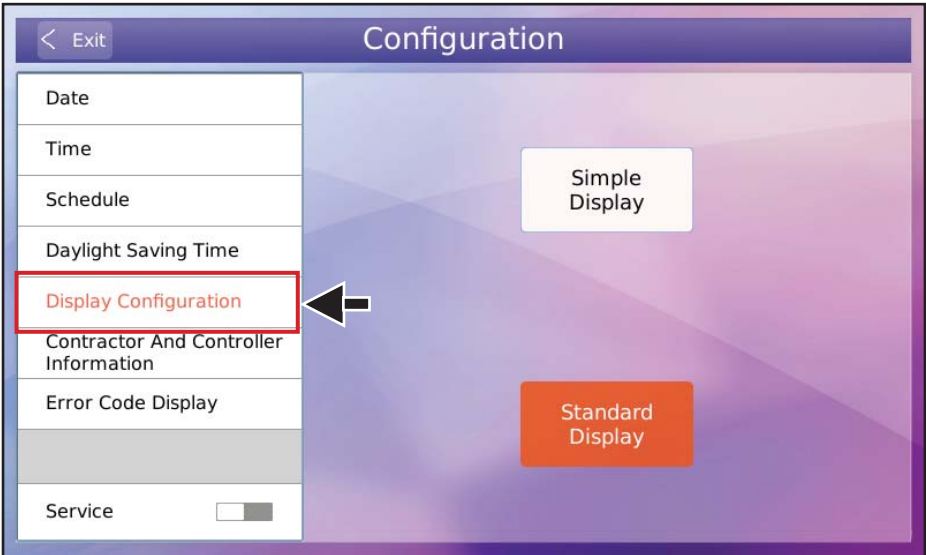

Figure 41. Display Type Settings



Figure 42. Standard Display

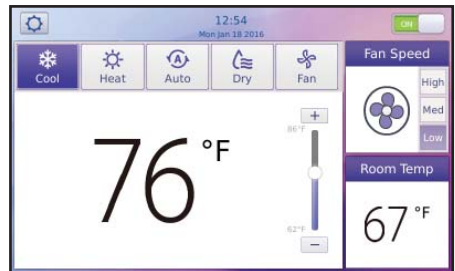
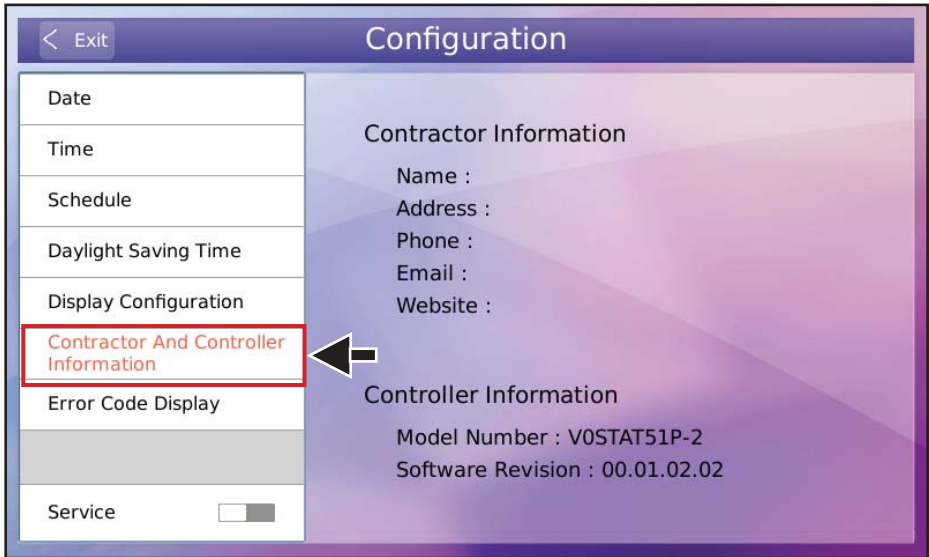

Figure 43. Simple Display

### View and Edit Contractor and Controller Information

1. Tap the Menu button on the Home screen and then tap the Contractor and Controller Information button.



**Figure 44. Contractor and Controller Information**

2. To edit the contractor information, tap to the right of any of the Contractor Information fields to activate keyboard.
3. Enter the name and contact information of the contractor who installed the controller.

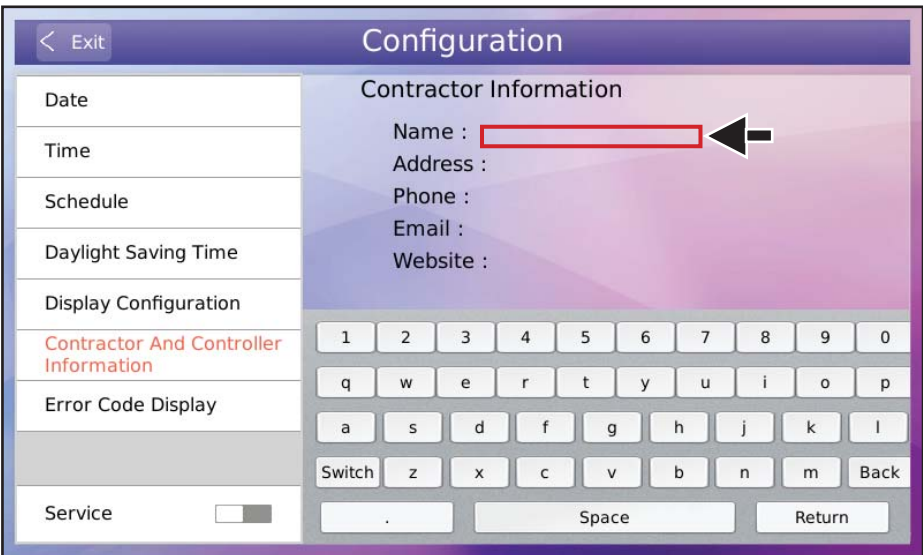

**Figure 45. Enter Contractor Information**

### View Error Code History

View the last ten error codes of connected indoor units.

1. Tap the Menu button on the Home screen and then tap the Error Code Display button.
  - The last ten error codes display.
  - If the indoor unit has multiple simultaneous errors, they will be displayed on the same row. Each row can display up to six error codes.

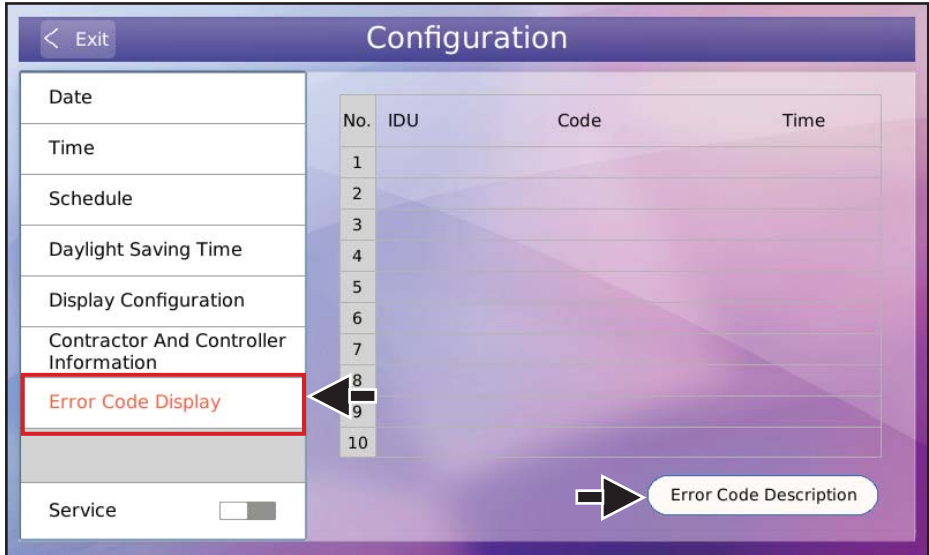

Figure 46. View Error Code History

2. Tap the Error Code Description button to access the error code description screen.
3. Tap the back button to return to the error code history screen.

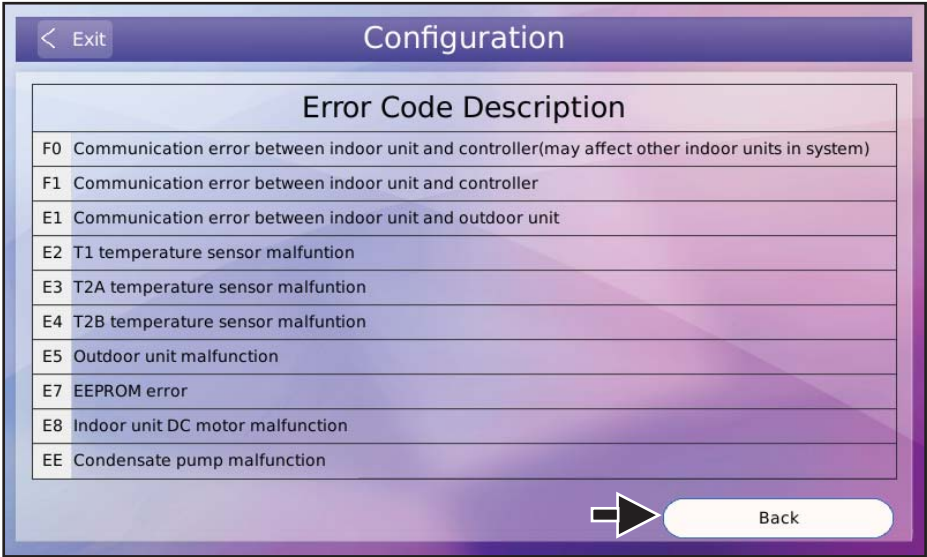

Figure 47. View Error Code Description from Controller

#### Complete List of Error Code Descriptions

Error Code	Description
F0	Communication error between the indoor unit and the wired controller (may affect other indoor units in the system)
F1	Communication error between the indoor unit and the controller
F2	Controller EEPROM error
E1	Communication error between the indoor unit and the outdoor unit
E2	T1 temperature sensor error
E3	T2A temperature sensor error
E4	T2B temperature sensor error
E5	Outdoor unit error
E6	Fan motor error
E7	Indoor unit EEPROM error
E8	Indoor unit DC motor error
EE	Condensate pump error

## Service

- Access the Service Configuration Options screen by tapping the Menu button on the Home screen and then swiping right on the Service button.
- Use the keypad to enter your password.
- The user password can be changed on the Lock screen within the Service Configuration Options. The default password is 0000.

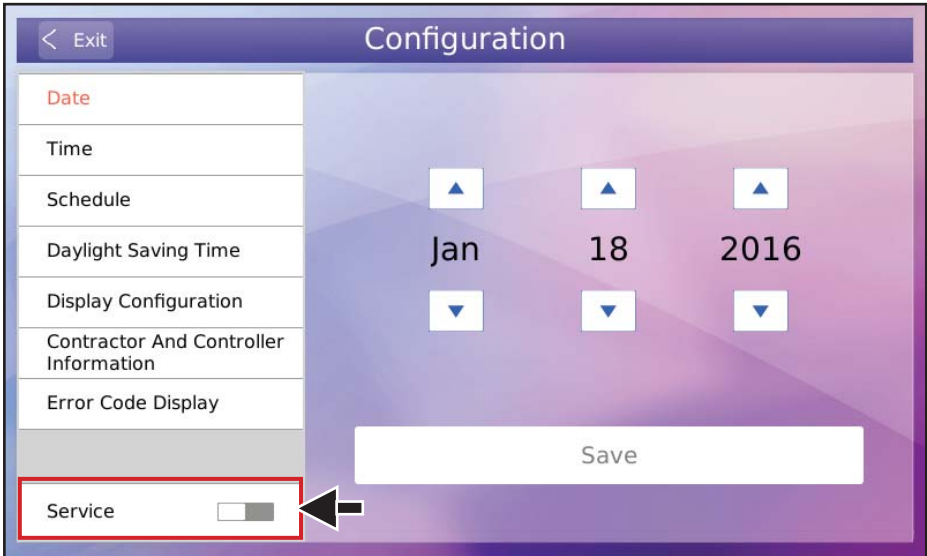

Figure 48. Access Service Options

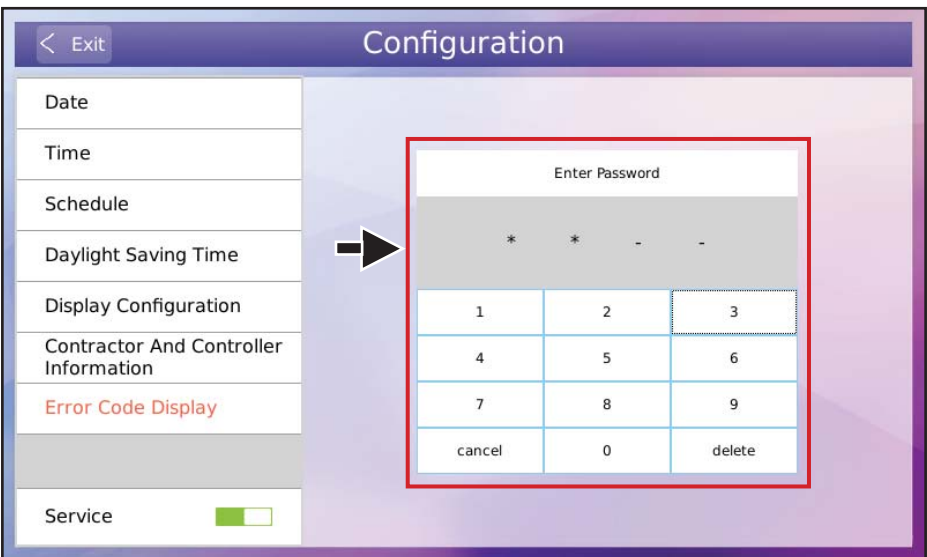

Figure 49. Enter Password

### Set System Type

Identify the system as heat recovery (VRA) or as heat pump (VPA).

1. Tap the Menu button on the Home screen.
2. Tap the Service button and then enter your password.
3. Tap the System Type button.
4. Tap the Heat Pump button to identify the system as a heat pump system. The auto mode functionality will not display on the Home screen.
5. Tap the Heat Recovery button to identify the system as a heat recovery system.

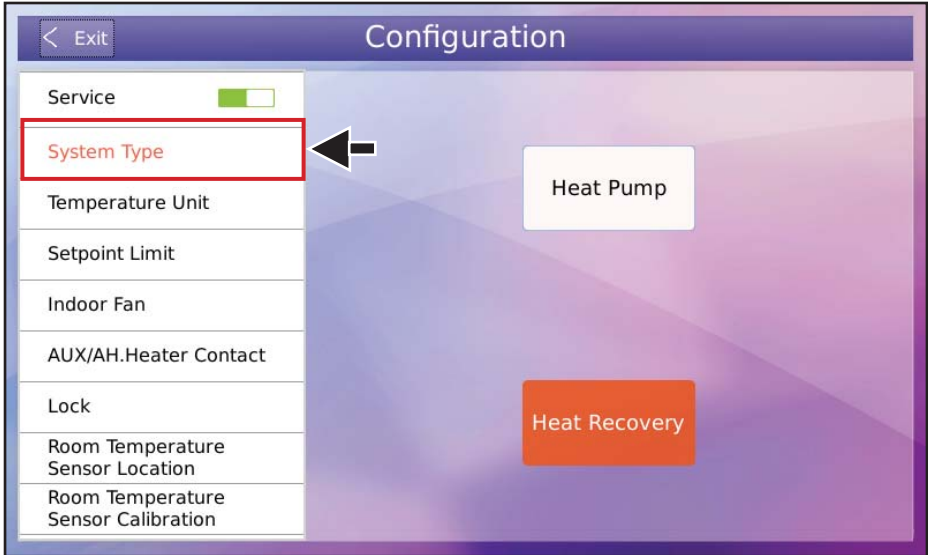

Figure 50. Set System Type

### Set Temperature Unit

Set the unit of temperature to be displayed on the controller.

1. Tap the Menu button on the Home screen.
2. Tap the Service button and then enter your password.
3. Tap the Temperature Unit button.
4. Tap the °F button to display and operate the system in degrees Fahrenheit.
5. Tap the °C button to display and operate the system in degrees Celsius.

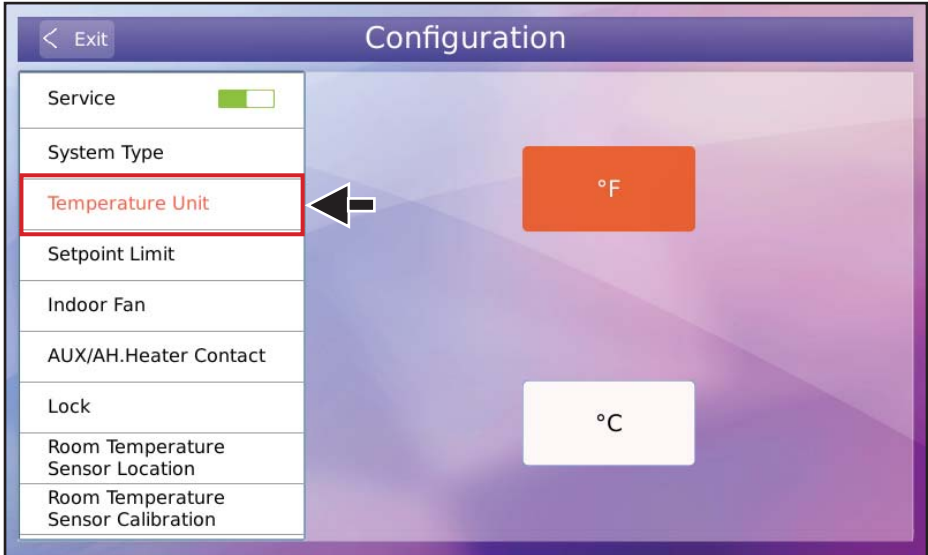

Figure 51. Set Temperature Unit

### Set Temperature Setpoint Range

Set the unit of temperature to be displayed on the controller.

1. Tap the Menu button on the Home screen.
2. Tap the Service button and then enter your password.
3. Tap the Setpoint Limit button.
4. Tap the up-arrow and down-arrow buttons to set limits for the cooling setpoint. During auto, cooling or dry mode, the temperature setpoint cannot be set lower than this value.
5. Tap the up-arrow and down-arrow buttons to set limits for the heating setpoint. During auto or heating mode, the temperature setpoint cannot be set higher than this value.

**NOTE** - The setpoint range is 62°F to 86°F (17°C to 30°C). This is the default setting.

**NOTE** - Scheduled operation is not affected by these settings.

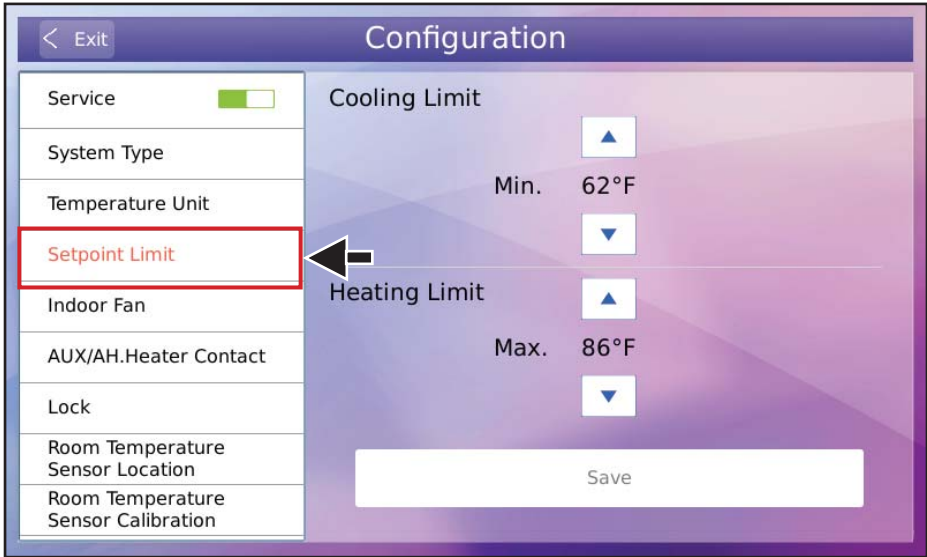

Figure 52. Set Temperature Setpoint Range



### Set Fan Control

Set the function of the indoor unit fan when setpoint is satisfied.

1. Tap the Menu button on the Home screen.
2. Tap the Service button and then enter your password.
3. Tap the Indoor Fan button.
4. **Cooling** - Tap the Fan ON button (default) to make the indoor unit fan continue to run when the cooling setpoint is satisfied. Tap the Fan OFF button to make the indoor unit fan stop running when the cooling setpoint is satisfied. **NOTE** - *The default setting, Fan On, is recommended for highest efficiency.*
5. **Heating** - Tap the Fan ON button (default) to make the indoor unit fan continue to run when the heating setpoint is satisfied. Tap the Fan OFF button to make the indoor unit fan stop running when the heating setpoint is satisfied.

**NOTE** - *The default setting, Fan On, is recommended for highest efficiency.*

**NOTE** - *Controller requires confirmation that fan operation may stop when using alternate heat connected through the HHE Relay Kit Four Dry-Contact board.*

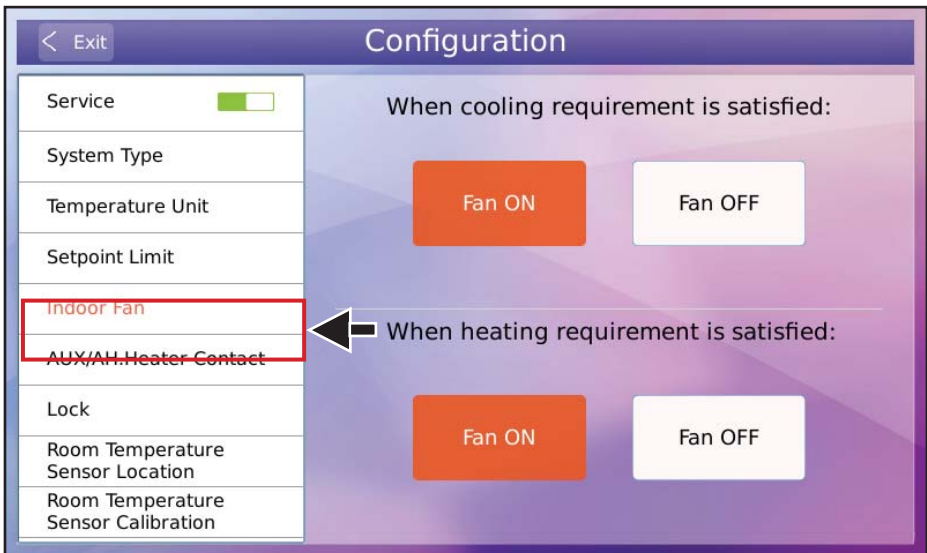

Figure 53. Set Fan Control

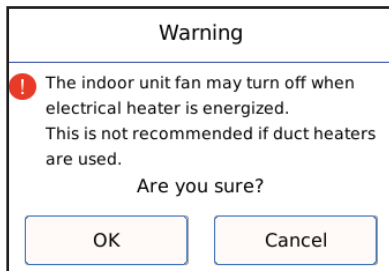

Figure 54. Confirm Heating Fan Off

### Adjust Auxiliary / Alternative Heat Settings

Set the running parameters of auxiliary or alternative heat connected through the HHE Relay Kit Four Dry-Contact board.

1. Tap the Menu button on the Home screen.
2. Tap the Service button and then enter your password.

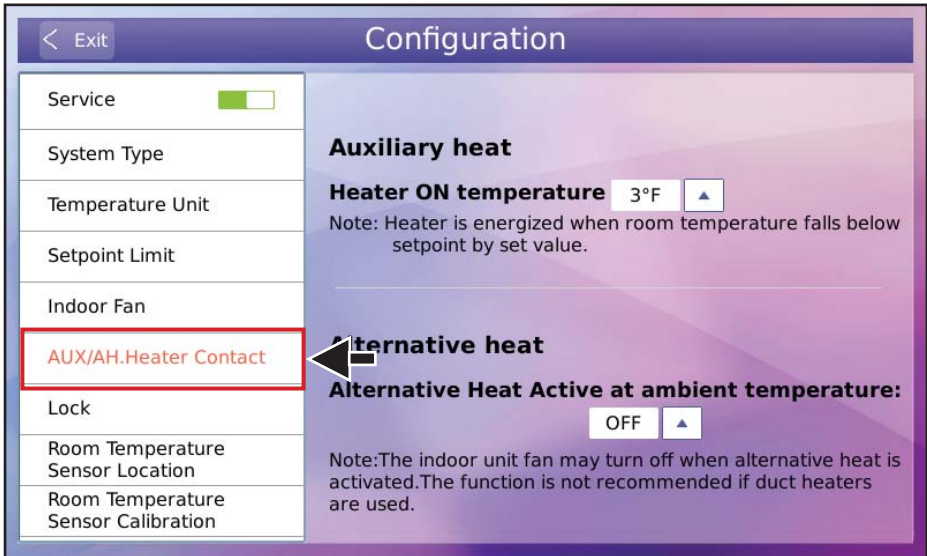

Figure 55. Set Heat Source Control

3. Tap the AUX/AH.Heater Contact button.

### Auxiliary Heat Settings

- Tap the arrow button next to "Heater ON temperature" in the Auxiliary heat area to display optional temperatures (3°F / 5°F in Fahrenheit, or 2°C / 3°C in Celsius). Tap to select a temperature value.
- This temperature option indicates that the heater will be enabled when the sensor temperature is 3°F / 5°F (or 2°C / 3°C in Celsius) lower than the set temperature.

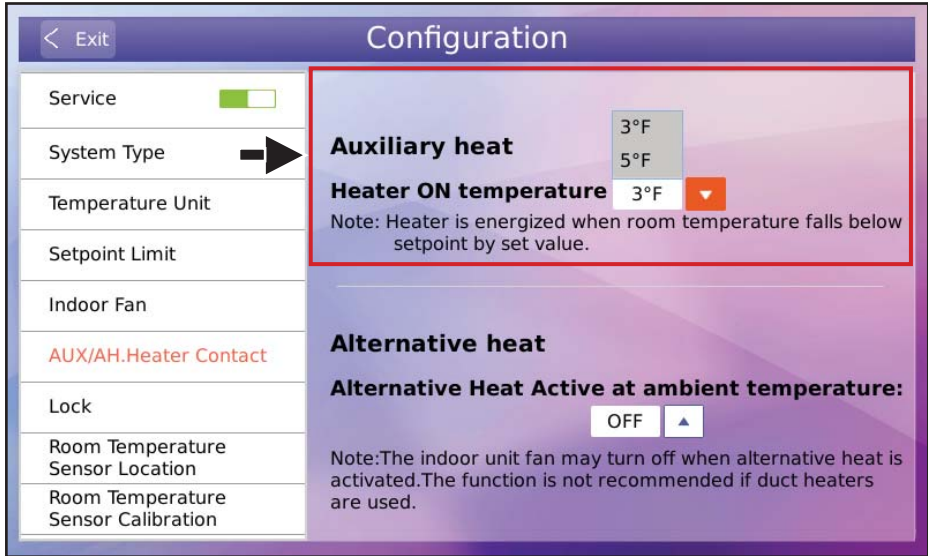

Figure 56. Set Auxiliary Heat Control

**NOTE** - Auxiliary heat is only available when HHE Relay Kit is connected.

**Alternative Heat Control**

- Tap the arrow button next to “Alternative Heat Active at ambient temperature” in the Alternative heat area to display optional temperatures (7°F, 10°F, 15°F, 20°F, 25°F, 30°F, 35°F, 40°F and OFF in Fahrenheit, or -14°C, -12°C, -9°C, -7°C, -4°C, -1°C, 2°C, 4°C and OFF in Celsius). Tap to select a temperature value.
- When the outdoor temperature is lower than the selected temperature and the indoor unit is in heating mode, the indoor unit will stop providing heat and the alternative heat will be enabled.
- When OFF is selected, the indoor unit will operate normally in heating mode.

**NOTE** - Alternative heat is only available when HHE Relay Kit is connected.

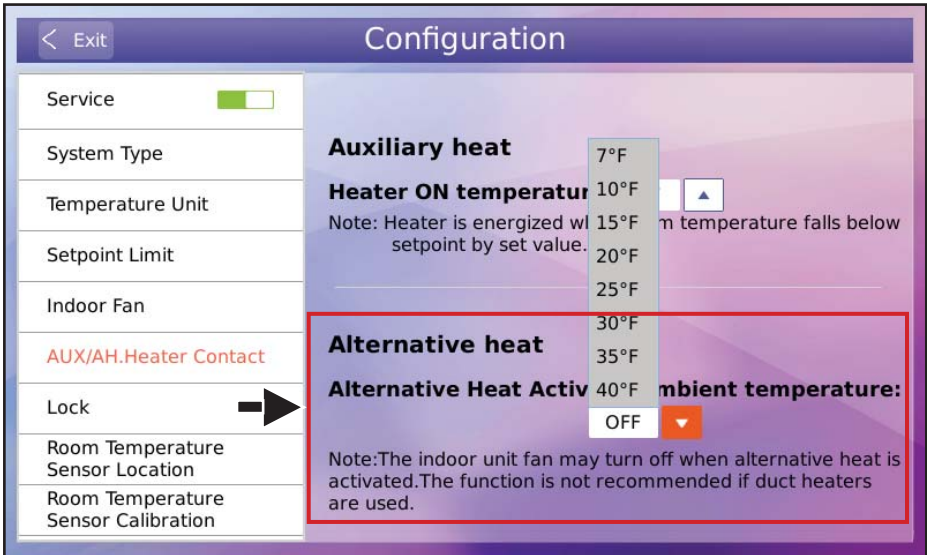

**Figure 57. Set Alternative Heat Control**

## Lock Function

Controller functions can be locked to prevent use of specific functions.

1. Tap the Menu button on the Home screen.
2. Tap the Service button and then enter your password.
3. Tap the Lock button.
4. Tap the button of each function you want to lock. The button will turn orange to indicate the function is locked.
5. Tap the function button again to unlock that function.

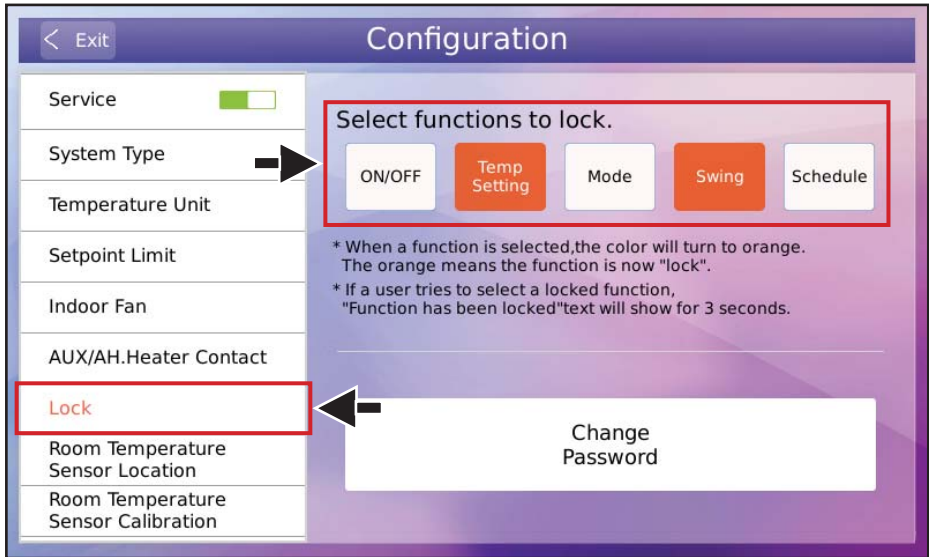

Figure 58. Set Lock Function

Table 4. Lock Function Descriptions

Lock Category	Description
ON/OFF	Locks the turning on/off function of the controller
Temp Setting (temperature setting lock)	Locks temperature adjustment on the controller
Mode	Locks the operation mode button action of the controller
Swing	Locks the swing button of the controller
Schedule	Locks the schedule settings in operation

### Change User Password for Service Configuration Access

1. Tap the Menu button on the Home screen.
2. Tap the Service button and then enter your password.
3. Tap the Lock button.
4. Tap the Change Password button.
5. Use the keypad to enter the current password then the new password.

**NOTE** - If password is lost, there is no reset function.

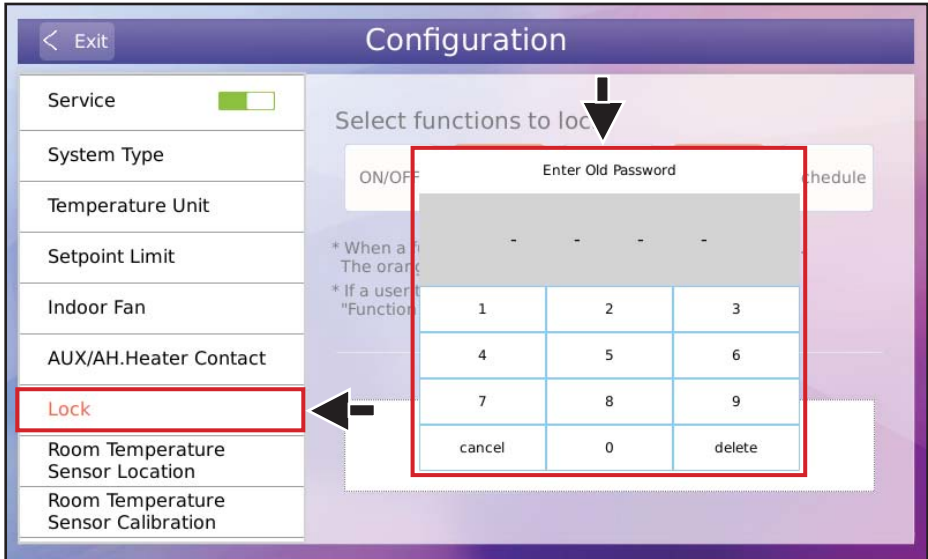

Figure 59. Change Password

### Set Room Temperature Sensor Location

Determine if the room temperature will be sensed using the controller sensor or the indoor unit sensor. This is the sensor the controller will use to decide when the setpoint has been satisfied.

1. Tap the Menu button on the Home screen.
2. Tap the Service button and then enter your password.
3. Tap the Room Temperature Sensor Location button.
4. Tap the Controller button to select the indoor temperature sensor of the controller.
5. Tap the Indoor Unit button to select the indoor temperature sensor of the indoor unit.

**NOTE** - If more than one indoor unit is controlled by this controller, the room temperature sensor location is permanently set to Controller and cannot be changed.

**NOTE** - If fresh air is being supplied directly to the indoor unit, Controller should be selected.



Figure 60. Set Room Temperature Sensor Location

### Set Room Temperature Sensor Calibration

If the indoor temperature displayed on the controller differs from the actual indoor temperature, use this screen to calibrate the sensor. The controller will add the value selected to the sensed temperature as selected on the sensor location screen. The correction ranges from -4°F to 4°F (or -2°C to 2°C).

1. Tap the Menu button on the Home screen.
2. Tap the Service button and then enter your password.
3. Tap the Room Temperature Sensor Calibration button.
4. Drag the round slider or tap the Increase or Decrease button to adjust and select the correction for indoor temperature sensor as required.
5. Tap the Save button to save the settings.

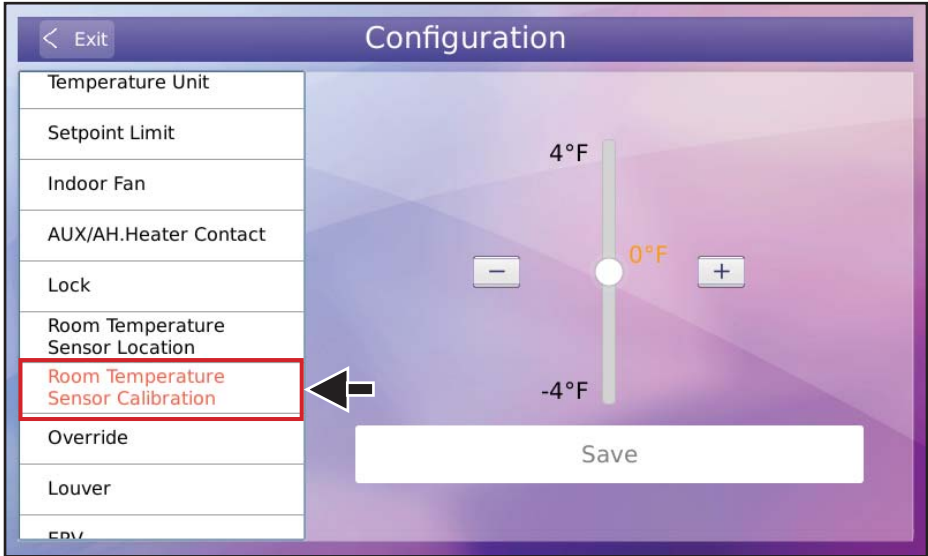

Figure 61. Set Room Temperature Sensor Calibration



### Set Override Function

Select the amount of time (override-period) the user will be able to override a scheduled event from the Home screen.

- To limit the user to only one override period, tap the appropriate button. See figure 63.
  - To allow the user to select from all of the over-ride periods, leave all buttons unselected.
1. Tap the Menu button on the Home screen.
  2. Tap the Service button and then enter your password.
  3. Tap the Override button.
  4. Tap the button for the amount of time to allow the user to override the current schedule or leave all unselected. Tap the button again to deselect it.

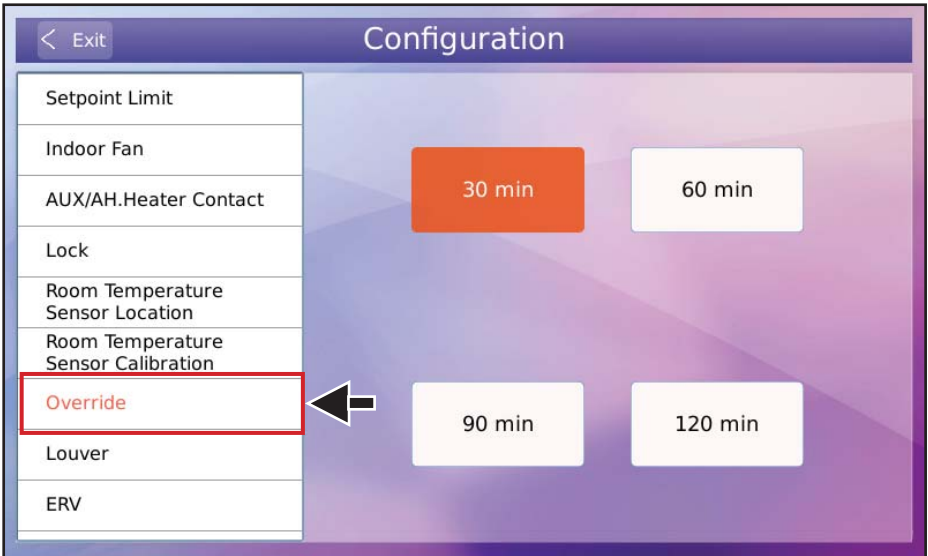

Figure 62. Set Override Function

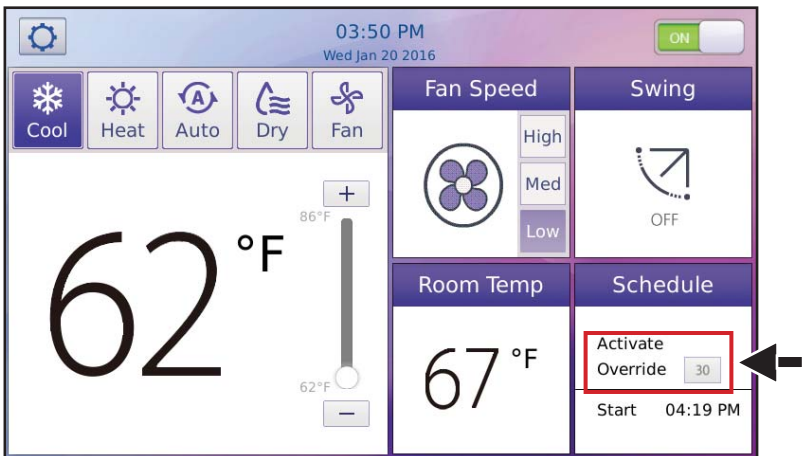

Figure 63. Example: Allow Users to Select Only 30 Minute Override-Period

### Set Louver Swing Function

Identify whether or not the indoor unit(s) connected to this controller has louvers.

1. Tap the Menu button on the Home screen.
2. Tap the Service button and then enter your password.
3. Tap the Louver button.
4. Tap the No button if any of the connected indoor unit do not have auto-swing louvers. The Swing button of the Home screen will be disabled.
5. Tap the Yes button if any of the connected indoor unit have auto-swing louvers.

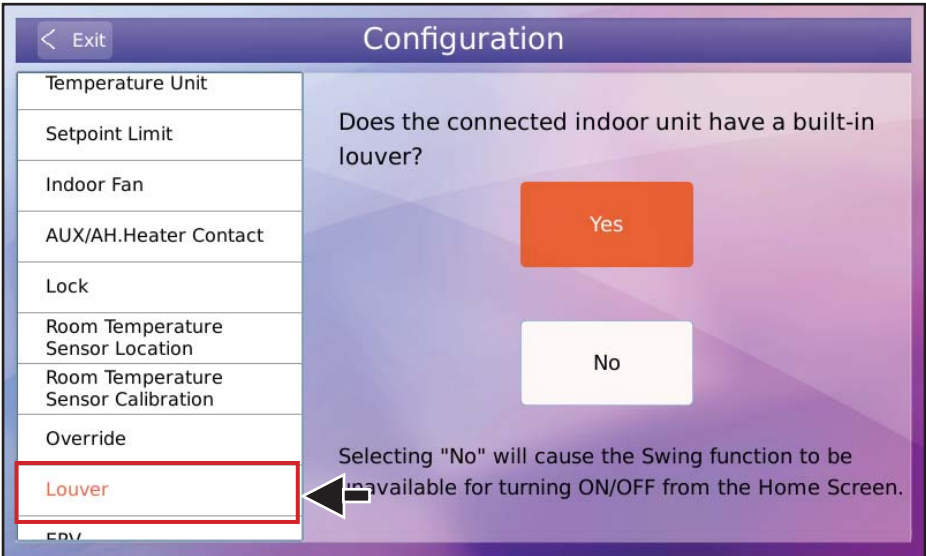

Figure 64. Set Louver Swing Function

### Configure ERV Settings (Future Revision)

1. This function is reserved for a future revision of the controller. Do not adjust default setting.

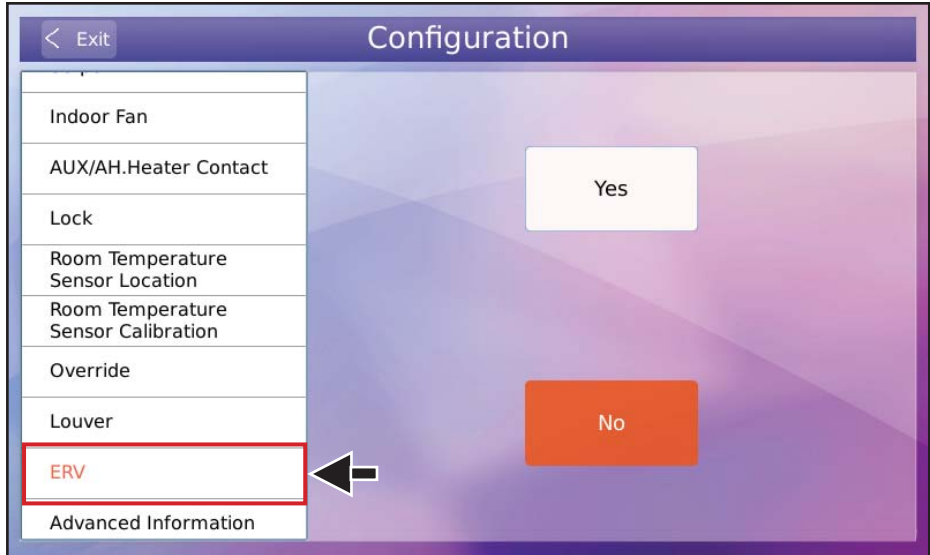

Figure 65. Identify Indoor Unit as Energy Recovery Ventilator

## Advanced Information

View indoor unit operating data, error code history and HHE Relay four dry-contact status.

1. Access the Advanced Information screen by tapping the Menu button on the Home screen. Then tap the Service button and enter your password.
2. Tap the Advanced Information button.

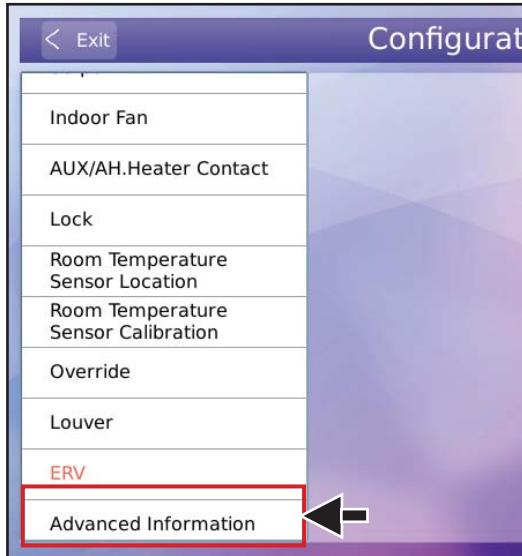

Figure 66. Advanced Information

### Indoor Unit Operating Data

View the current operation status of each indoor unit connected to the controller.

1. Tap the Menu button on the Home screen.
2. Tap the Service button and then enter your password.
3. Tap the Advanced Information button.
4. The Operating Data screen displays.
5. Tap the up and down arrows to switch between address numbers of connected indoor units and view the operating status of each indoor unit.

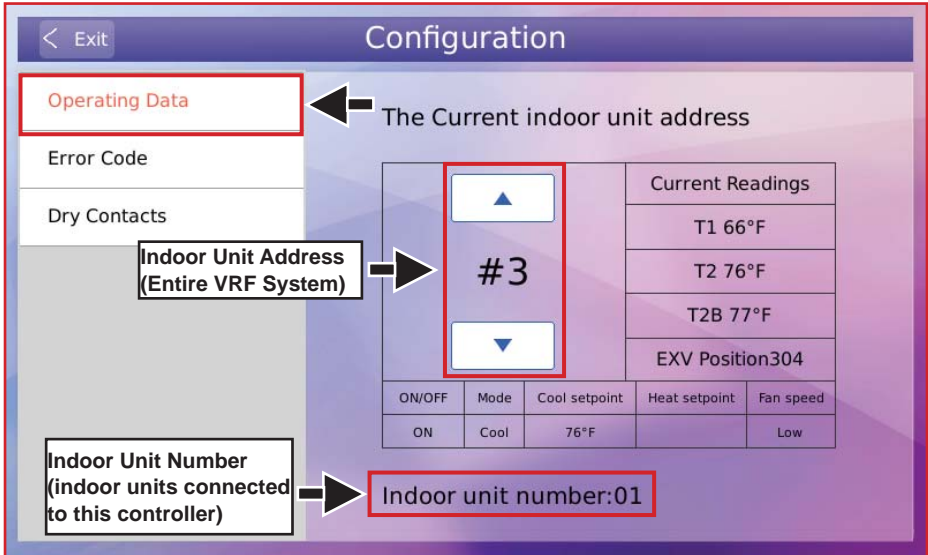

Figure 67. View Indoor Unit Operating Data

**Table 5. Indoor Unit Operating Data**

<b>Information Displayed</b>	<b>Description</b>
Address of connected indoor unit	Assigned during system commissioning
T1	Indoor unit temperature sensor
T2	Temperature in the middle of the indoor unit evaporator
T2B	Temperature in the outlet of the indoor unit evaporator
EXV Position	Openness of the indoor unit electronic expansion valve position Unit: Step
ON/OFF	On/off status
Mode	Operation mode
Cool setpoint	Set temperature for cooling
Heat setpoint	Set temperature for heating
Fan Speed	Set fan speed
Indoor unit number	Total number of connected indoor units

### Indoor Unit Error Code History

View the error code history for each indoor unit connected to the controller.

1. Tap the Menu button on the Home screen.
  2. Tap the Service button and then enter your password.
  3. Tap the Advanced Information button.
  4. Tap the Error Code button.
- The last ten error codes display.
  - If the indoor unit has multiple simultaneous errors, they will be displayed on the same row.
  - Each row can display up to six error codes.
- Tap the Error Code Description button to access the error code description screen.
  - Tap the Reset button to clear the screen and erase all message. **NOTE** - This will also erase the error code history in the user menu.

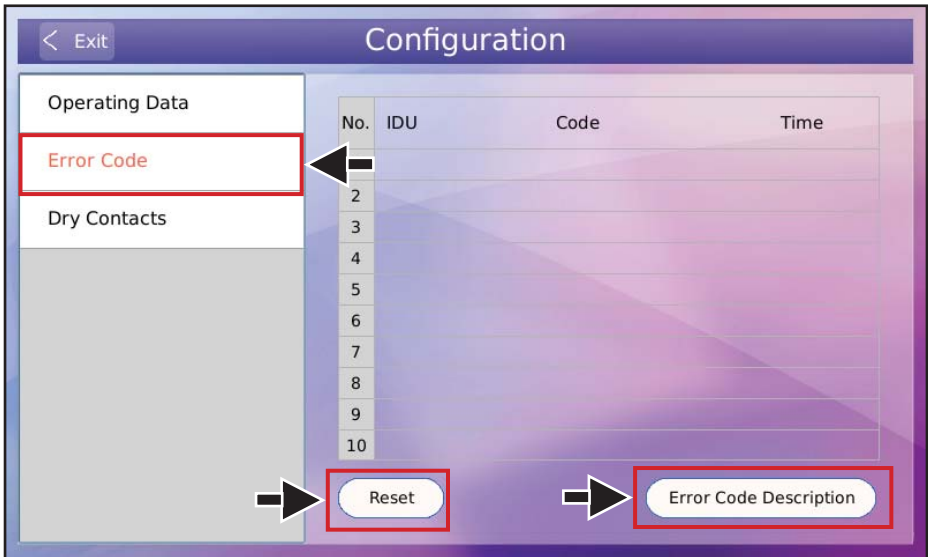

Figure 68. View Indoor Unit Error Code History

### HHE Relay Four Dry-Contact Status

View the HHE Relay four dry-contact status for each indoor unit connected to the controller.

1. Tap the Menu button on the Home screen.
2. Tap the Service button and then enter your password.
3. Tap the Advanced Information button.
4. Tap the Dry Contacts button.
5. Tap the up and down arrows to switch between connected indoor units and view the dry-contact status of each indoor unit.

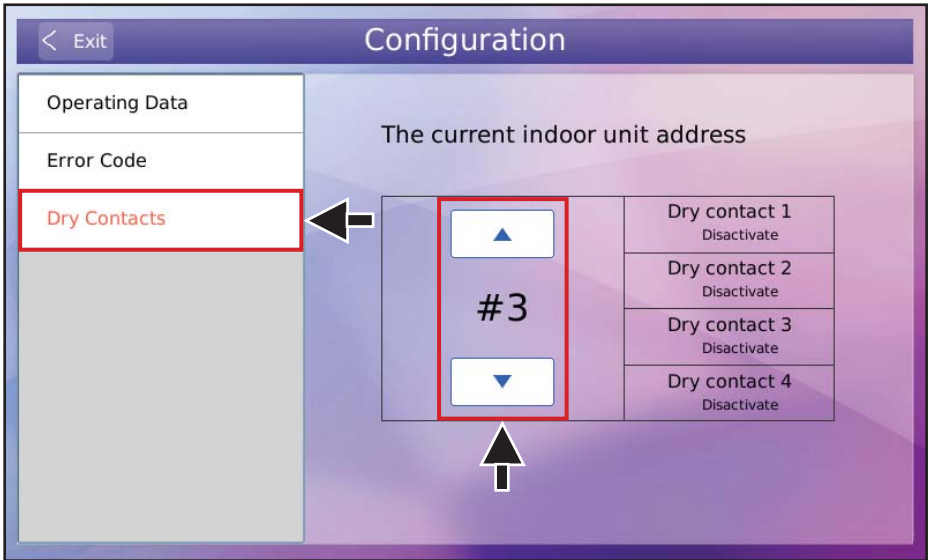

Figure 69. View HHE Relay Four Dry-Contact Status



## Firmware and Setting Information

View the firmware and setting information of the controller, import or export the controller settings or upgrade the firmware.

1. Tap the Menu button on the Home screen.
2. Tap the Service button and enter your password.
3. Tap the Firmware and Setting button.

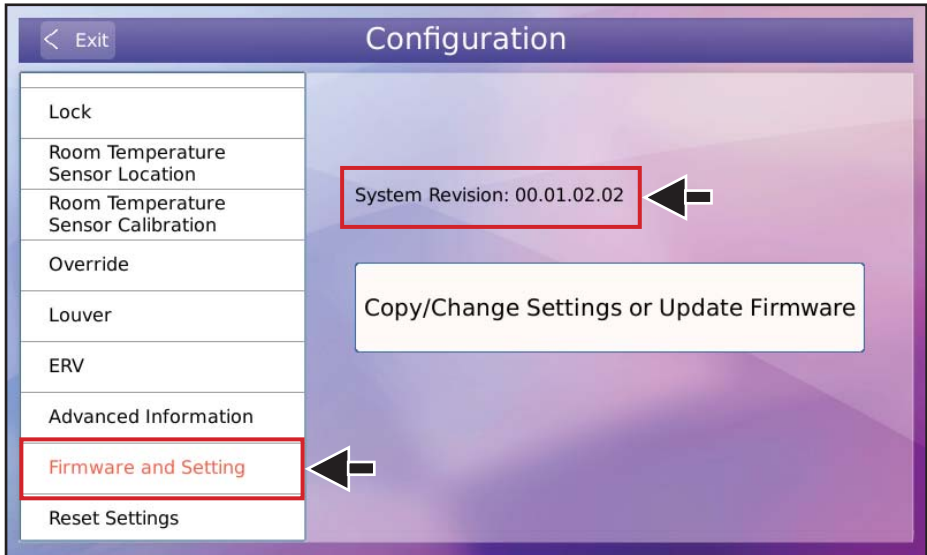

Figure 70. Firmware and Setting Information

### Copy/Change Settings or Update Firmware

View the controller software revision.

1. Tap the Menu button on the Home screen.
2. Tap the Service button and then enter your password.
3. Tap the Firmware and Setting button.
4. Tap the Copy/Change Settings or Update Firmware button.

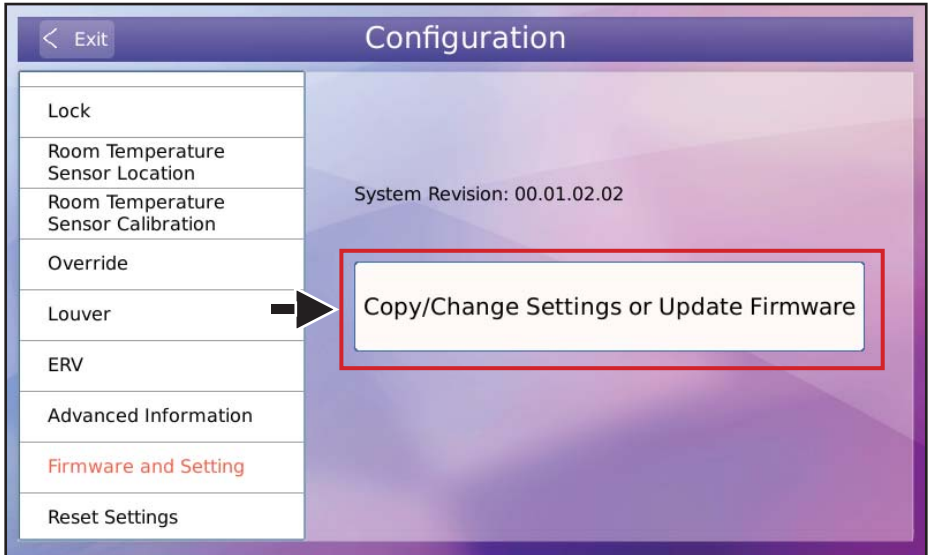

Figure 71. Copy/Change Settings or Update Firmware

### Export Settings to USB

Export the controller settings to the connected USB device.

1. Tap the Menu button on the Home screen.
2. Tap the Service button and then enter your password.
3. Tap the Firmware and Setting button.
4. Tap the Copy/Change Settings or Update Firmware button. A popup screen displays.
5. Tap the Copy Setting To USB button.
6. A popup displays when the copy has completed. Tap the OK button.

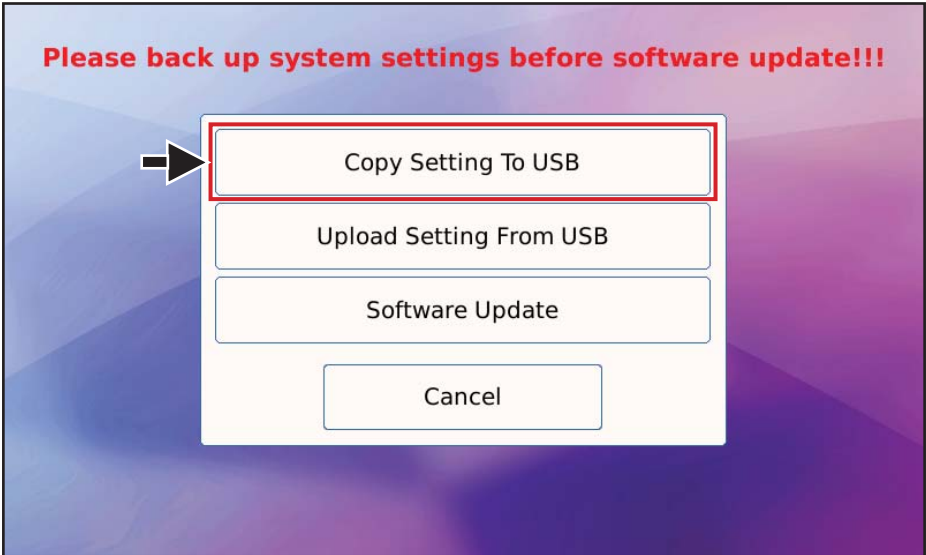

Figure 72. Export Settings to USB

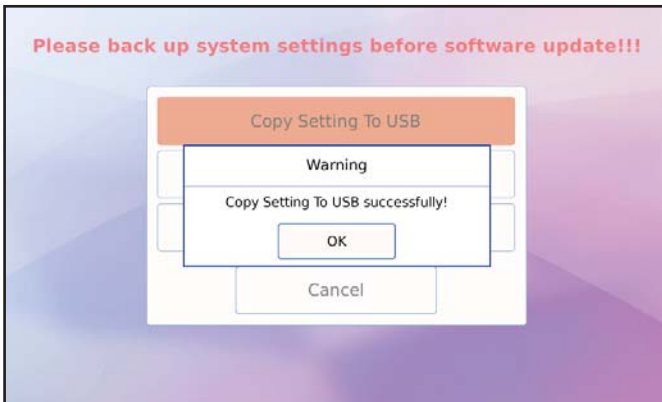

Figure 73. Export Settings to USB Complete

### Import Settings from USB

Import the controller settings.

1. Tap the Menu button on the Home screen.
2. Tap the Service button and then enter your password.
3. Tap the Firmware and Setting button.
4. Tap the Copy/Change Settings or Update Firmware button. A popup screen displays.
5. Tap the Upload Setting From USB button.
6. A popup displays when the import has completed. Tap the OK button.

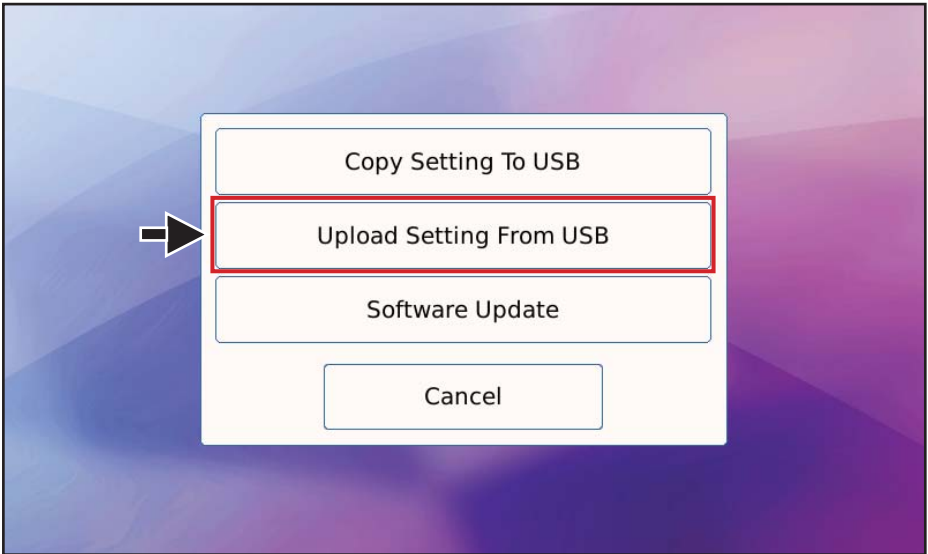

Figure 74. Import Settings from USB



Figure 75. Import Settings From USB Complete

## Update Software

**NOTE** - For software updates, check with your Lennox representative. Update the controller's software from the connected USB device.

1. Tap the Menu button on the Home screen.
2. Tap the Service button and then enter your password.
3. Tap the Firmware and Setting button.
4. Tap the Copy/Change Settings or Update Firmware button. A popup screen displays.

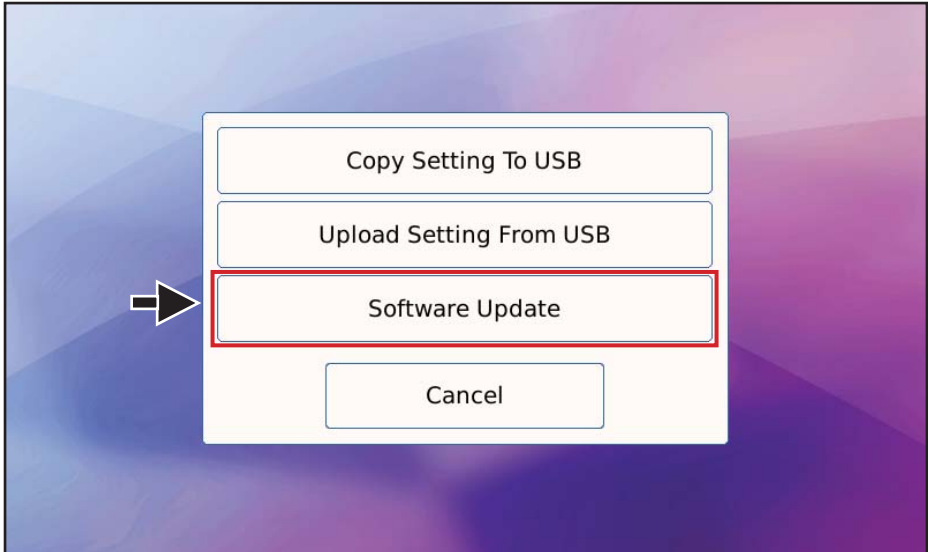

Figure 76. Update Software

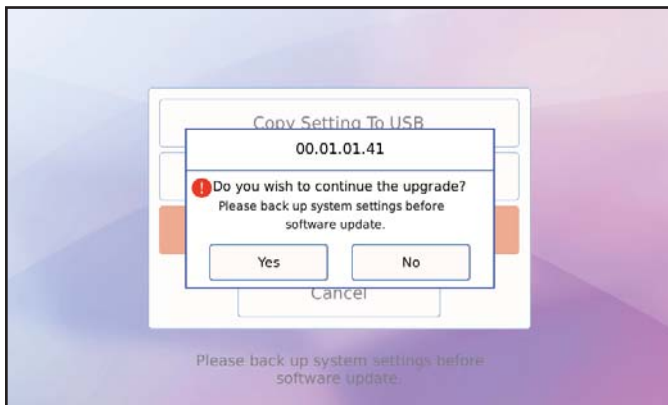
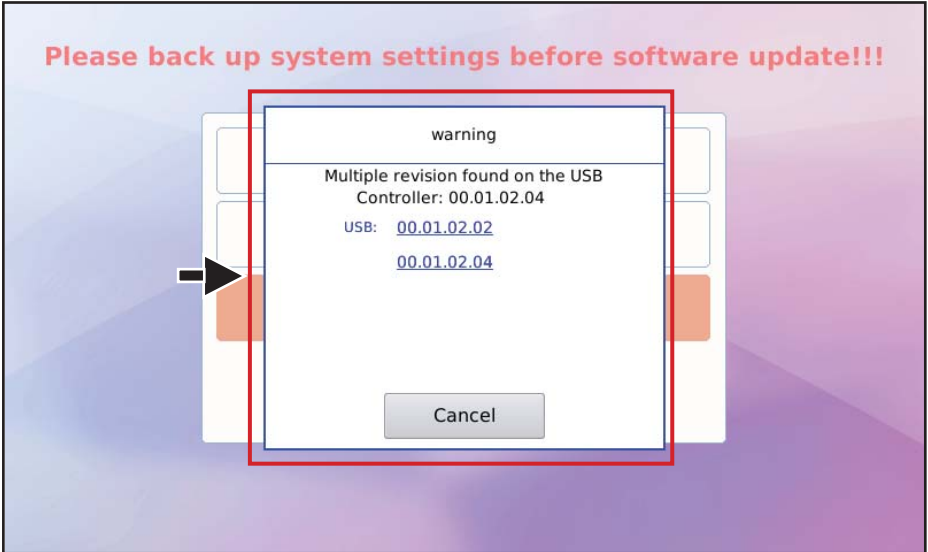

Figure 77. Confirm Update

5. Tap the Software Update button.
6. Select the appropriate update file from the displayed list.
7. Tap the OK button to continue.
8. Controller will restart to complete upgrade.

**NOTE** - All controller settings will be deleted. Save controller settings to USB device before updating.



**Figure 78. Select Software Revision**

#### **Software Update Best Practices**

- Always copy the existing settings to a USB before updating the controller.
- Only install the most recent software update even if you are behind more than one revision.

## Reset Settings

Restore all set parameters of the controller to factory defaults. This cannot be undone.

1. Tap the Menu button on the Home screen.
2. Tap the Service button and enter your password.
3. Tap the Reset Settings button on the left panel.
4. Tap the Reset Settings button in the center of the screen.
5. Tap the OK button to confirm reset.

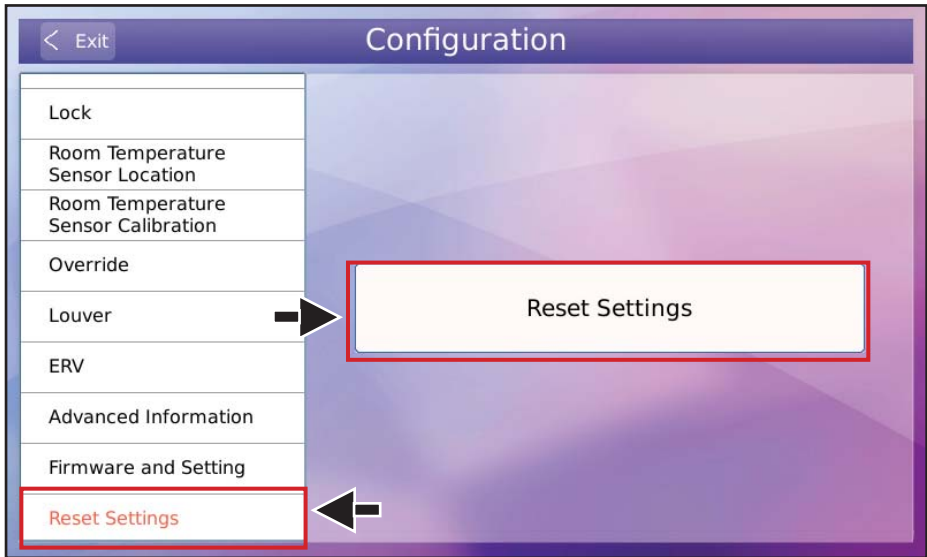

Figure 76. Reset Settings

**Table 6. Factory Default Settings**

<b>Option Category</b>	<b>Parameter Option</b>	<b>Factory Default</b>
<b>General Function Settings</b>	Date	January 1, 2010
	Time	12-hour format
	Schedule	None
	Daylight Saving Time	Disabled
	Display Configuration	Standard Display
	Contractor And Controller Information	Blank
	Error Code Display	Updated in real time
<b>Service Options</b>	System Type	Heat Recovery
	Temperature Unit	°F
	Setpoint Limit	Min. 62°F
		Max. 86°F
	Indoor Fan	Cooling Fan ON
		Heating Fan ON
	AUX/AH.Heater Contact	Auxiliary heat: 3°F
		Alternative heat: OFF
	Lock	No function locked
	Room Temperature Sensor Location	Controller
	Room Temperature Sensor Calibration	0°F
	Override	Not set
	Louver	Yes
	ERV	No
Advanced Information	Updated in real time	
Firmware and Setting	Display firmware information	
Reset Settings	-	