



01

02

03

04

05

06

07

08

09

10

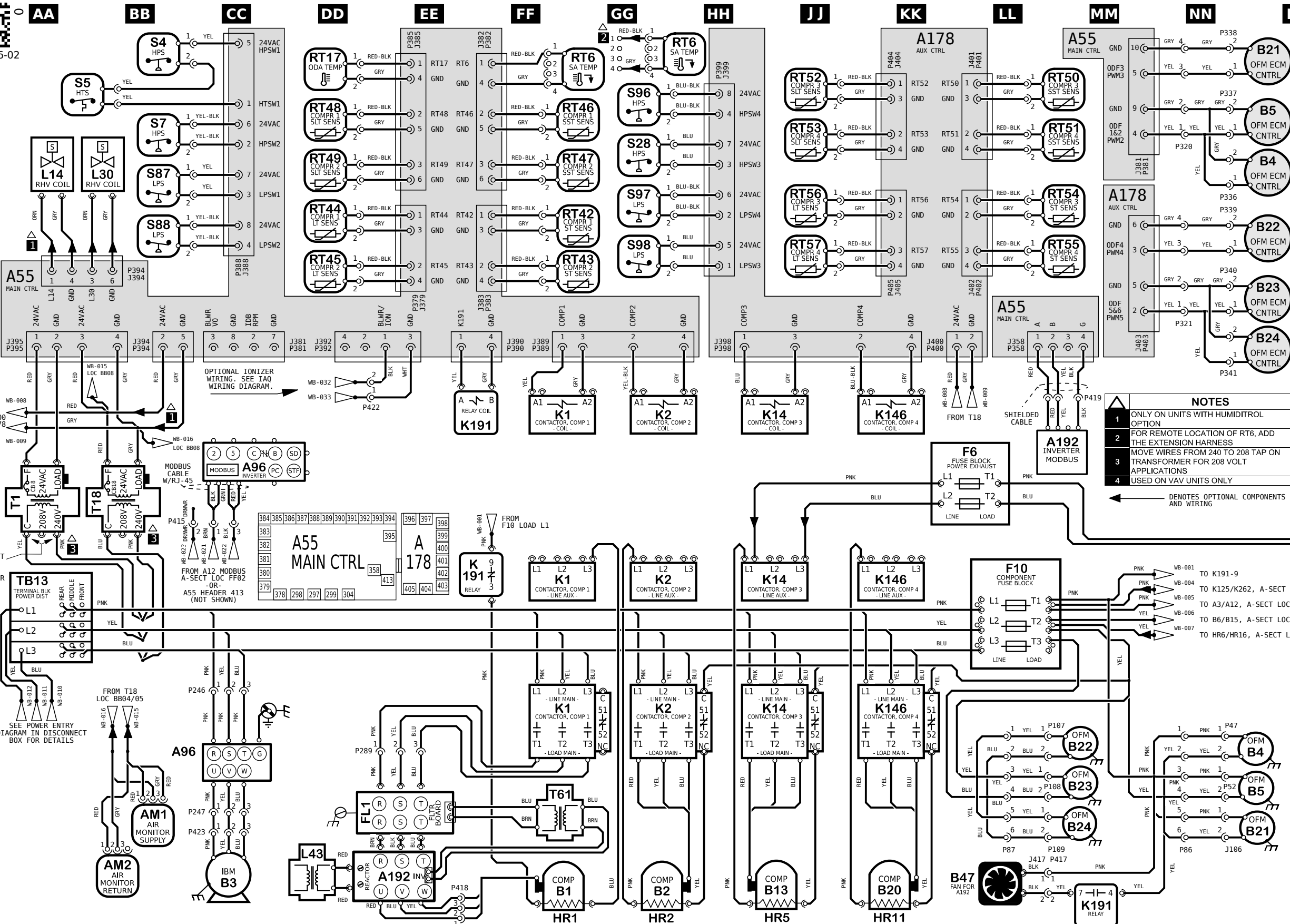

KEY LIST		
LOCATION	COMPONENT	DESCRIPTION
S806	A30	TRANSDUCER, SA DUCT PRESSURE
CC05/08	A96	CONTROL INVERTER, BLOWER
MM05,EE10	A192	INVERTER, COMPRESSOR 1
BB09	AM1, AM2	AIR MONITOR, SUPPLY/RETURN, IAQ-TVOC
FF/GG/JJ/KK10	B1, B2, B13, B20	COMPRESSOR 1, 2, 3, 4
CC10	B3	MOTOR, BLOWER
PP02/08/09	B4, B5,	MOTOR, OUTDOOR FAN 1, 2, 3, 4, 5, 6
PP01/09	B21	
PP03, MM08	B22,	
PP03, MM09	B23,	
PP04, MM09	B24	
QQ09	B10, B11	MOTOR, EXHAUST FAN 1, 2
LL10	B47	MOTOR, COOLING FAN FOR A192
QQ09	C6, C8	CAPACITOR, EXHAUST FAN 1, 2
LL05	F6	FUSE, EXHAUST FAN
LL07	F10	FUSE, COMPONENT
EE09	FL1	FILTER BOARD
FF/GG/JJ/KK10	HR1, HR2, HR5, HR11	HEATER, COMPRESSOR 1, 2, 3, 4
FF/GG05,06,08	K1, K2,	CONTACTOR, COMPRESSOR 1, 2, 3, 4
JJ/KK05,06,08	K14, K146	
QQ07	K65, K231	RELAY, EXHAUST FAN 1, 2
EE05/06, MM10	K191	RELAY, CRANKCASE HEATER 1
EE06	K203	RELAY, INVERTER CONTROL
AA02	L14, L30	VALVE, SOLENOID, REHEAT COIL 1, 2
DD09	L43	REACTOR INVERTER
GG01	RT6	SENSOR, A55 DISCHARGE (IMC)
DD01	RT17	SENSOR, OUTSIDE AIR TEMP
GG03, MM02/03	RT42, RT43, RT54, RT55	SENSOR, SUCTION TEMP., COMP 1, 2, 3, 4
DD03, JJ02/03	RT44, RT45, RT56, RT57	SENSOR, LIQUID TEMP., COMP 1, 2, 3, 4
GG02, MM01/02	RT46, RT47, RT50, RT51	SENSOR, SAT. SUCT TEMP., COMP 1, 2, 3, 4
DD01/02, JJ01/02	RT48, RT49, RT52, RT53	SENSOR, SAT. LIQUID TEMP., COMP 1, 2, 3, 4
BB01/02, GG02/01	S4, S7, S28, S96	LIMIT, HI PRESS. SWITCH, COMP 1, 2, 3, 4
AA01	S5	LIMIT, HI TEMP. SWITCH, COMP 1
BB02/03, GG03/02	S87, S88, S98, S97	SWITCH, LOW PRESS., COMP. 1, 2, 3, 4
AA06	T1	TRANSFORMER, CONTROL
BB06	T18	TRANSFORMER, CONTACTOR
FF09	T61	TRANSFORMER, INV INTERNAL POWER
AA07	TB13	TERMINAL STRIP, POWER DISTRIBUTION

NOTES

- 1 ONLY ON UNITS WITH HUMIDITROL OPTION
- 2 FOR REMOTE LOCATION OF RT6, ADD THE EXTENSION HARNESS
- 3 MOVE WIRES FROM 240 TO 208 TAP ON TRANSFORMER FOR 208 VOLT APPLICATIONS
- 4 USED ON VAV UNITS ONLY

← DENOTES OPTIONAL COMPONENTS AND WIRING

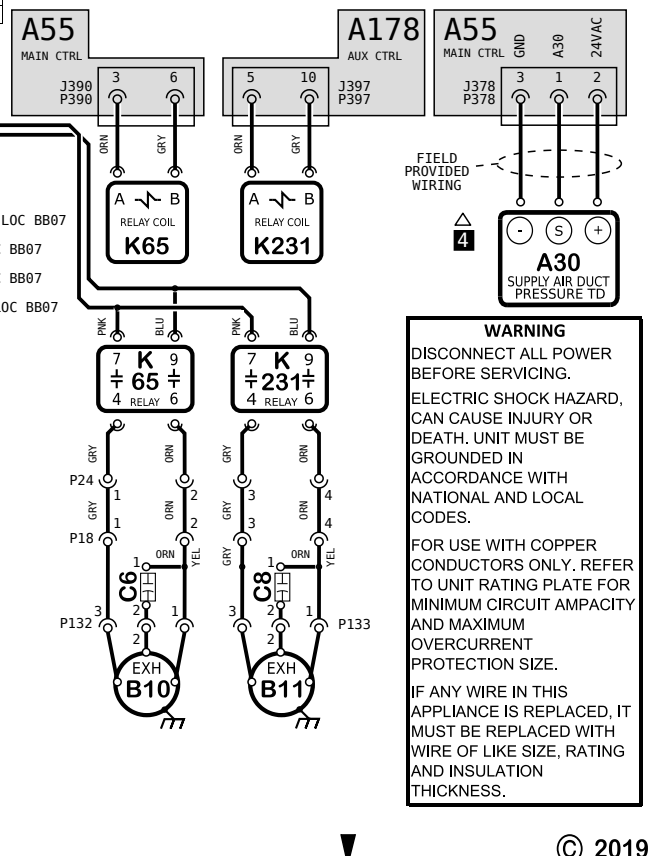

WARNING

DISCONNECT ALL POWER BEFORE SERVICING. ELECTRIC SHOCK HAZARD, CAN CAUSE INJURY OR DEATH. UNIT MUST BE GROUNDED IN ACCORDANCE WITH NATIONAL AND LOCAL CODES.

FOR USE WITH COPPER CONDUCTORS ONLY. REFER TO UNIT RATING PLATE FOR MINIMUM CIRCUIT AMPACITY AND MAXIMUM OVERCURRENT PROTECTION SIZE.

IF ANY WIRE IN THIS APPLIANCE IS REPLACED, IT MUST BE REPLACED WITH WIRE OF LIKE SIZE, RATING AND INSULATION THICKNESS.

Model: LCM, LGM 210U, 240U, 300U - Y-VOLT
COOLING - MSAV NO BYPASS -OR- VAV - 4 COMPRESSORS, 6 CONDENSER FANS

Voltage: 208-240/3/60 (Y)
Supersedes: 538096-01 Form No: 538096-02 Rev: 0

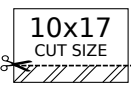
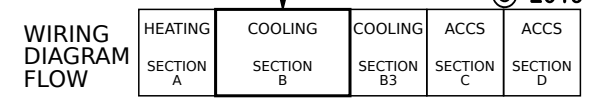

REV	EC NO.	DATE	BY	APVD	REVISION NOTE
---	CN-010356E	08-02-2022	MXR6	JAL21	ORIGINATED AT PD&R CARROLLTON, TX

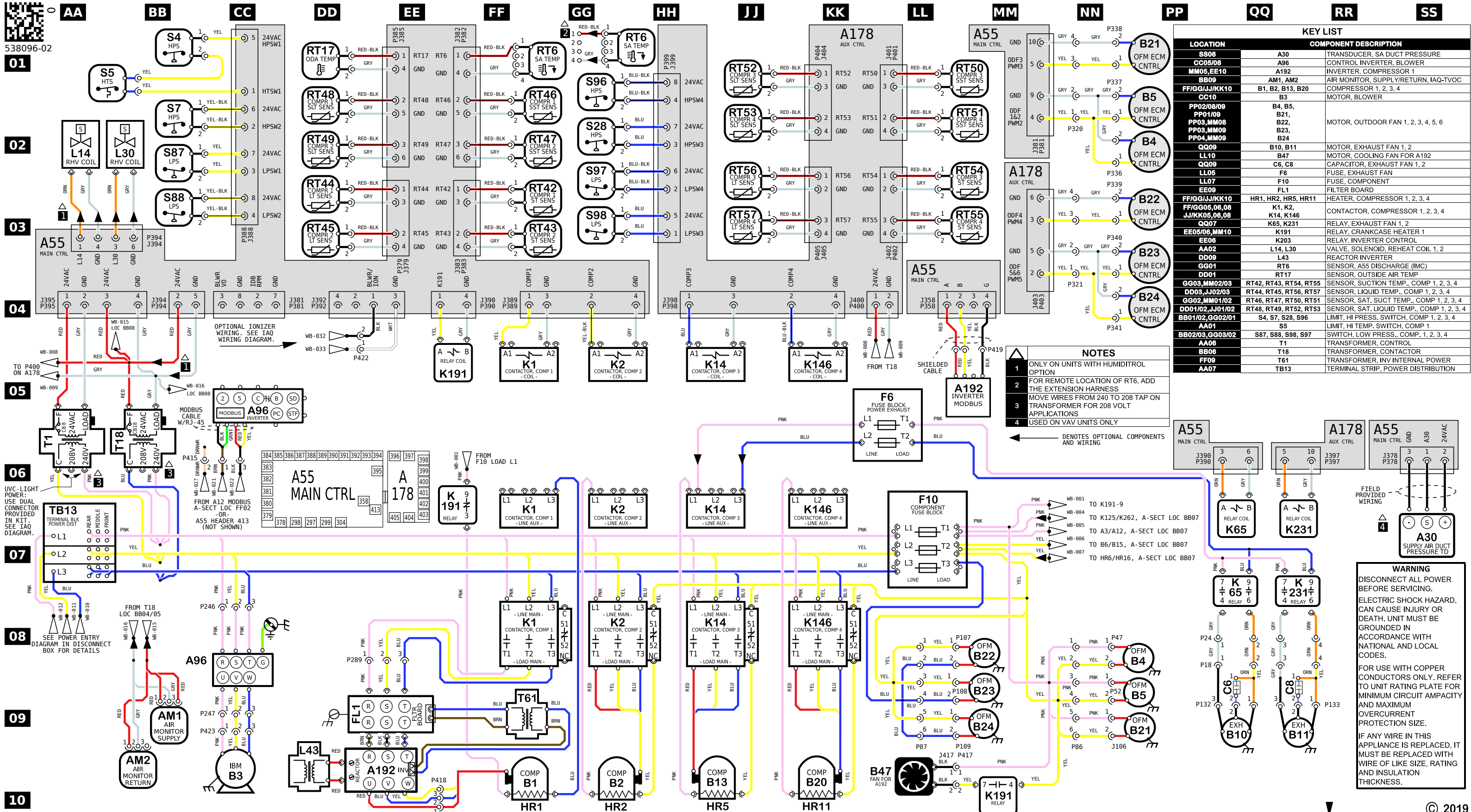

KEY LIST		
LOCATION	COMPONENT DESCRIPTION	
S506	A30	TRANSDUCER, SA DUCT PRESSURE
CC05/08	A96	CONTROL INVERTER, BLOWER
MM05,EE10	A192	INVERTER, COMPRESSOR 1
BB09	AM1, AM2	AIR MONITOR, SUPPLY/RETURN, IAQ-TVOC
FF/GG/JJ/KK10	B1, B2, B13, B20	COMPRESSOR 1, 2, 3, 4
CC10	B3	MOTOR, BLOWER
PP02/08/09	B4, B5,	MOTOR, OUTDOOR FAN 1, 2, 3, 4, 5, 6
PP01/09	B22,	
PP03, MM08	B23,	
PP04, MM09	B24	
QQ09	B10, B11	MOTOR, EXHAUST FAN 1, 2
LL10	B47	MOTOR, COOLING FAN FOR A192
QQ09	C6, C8	CAPACITOR, EXHAUST FAN 1, 2
LL05	F6	FUSE, EXHAUST FAN
LL07	F10	FUSE, COMPONENT
EE09	FL1	FILTER BOARD
FF/GG/JJ/KK10	HR1, HR2, HR5, HR11	HEATER, COMPRESSOR 1, 2, 3, 4
FF/GG05,06,08	K1, K2,	CONTACTOR, COMPRESSOR 1, 2, 3, 4
JJ/KK05,06,08	K14, K146	
QQ07	K65, K231	RELAY, EXHAUST FAN 1, 2
EE05/06, MM10	K191	RELAY, CRANKCASE HEATER 1
EE06	K203	RELAY, INVERTER CONTROL
AA02	L14, L30	VALVE, SOLENOID, REHEAT COIL 1, 2
DD09	L43	REACTOR INVERTER
GG01	RT6	SENSOR, A55 DISCHARGE (IMC)
DD01	RT17	SENSOR, OUTSIDE AIR TEMP
GG03, MM02/03	RT42, RT43, RT54, RT55	SENSOR, SUCTION TEMP., COMP 1, 2, 3, 4
DD03, JJ02/03	RT44, RT45, RT56, RT57	SENSOR, LIQUID TEMP., COMP 1, 2, 3, 4
GG02, MM01/02	RT46, RT47, RT50, RT51	SENSOR, SAT. SUCT TEMP., COMP 1, 2, 3, 4
DD01/02, JJ01/02	RT48, RT49, RT52, RT53	SENSOR, SAT. LIQUID TEMP., COMP 1, 2, 3, 4
BB01/02, GG02/01	S4, S7, S28, S96	LIMIT, HI PRESS. SWITCH, COMP 1, 2, 3, 4
AA01	S5	LIMIT, HI TEMP. SWITCH, COMP 1
BB02/03, GG03/02	S87, S88, S98, S97	SWITCH, LOW PRESS., COMP. 1, 2, 3, 4
AA06	T1	TRANSFORMER, CONTROL
BB06	T18	TRANSFORMER, CONTACTOR
FF09	T61	TRANSFORMER, INV INTERNAL POWER
AA07	TB13	TERMINAL STRIP, POWER DISTRIBUTION

- NOTES**
- 1 ONLY ON UNITS WITH HUMIDITROL OPTION
 - 2 FOR REMOTE LOCATION OF RT6, ADD THE EXTENSION HARNESS
 - 3 MOVE WIRES FROM 240 TO 208 TAP ON TRANSFORMER FOR 208 VOLT APPLICATIONS
 - 4 USED ON VAV UNITS ONLY
- ← DENOTES OPTIONAL COMPONENTS AND WIRING

Model: LCM, LGM 210U, 240U, 300U - Y-VOLT Voltage: 208-240/3/60 (Y)
 COOLING - MSAV NO BYPASS -OR- VAV - 4 COMPRESSORS, 6 CONDENSER FANS Supersedes: 538096-01 Form No: 538096-02 Rev: 0

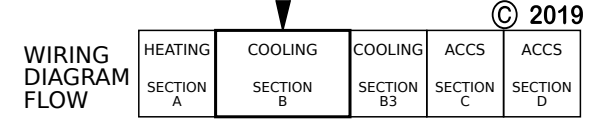

REV	EC NO.	DATE	BY	APVD	REVISION NOTE
---	CN-010356E	08-02-2022	MXR6	JAL21	ORIGINATED AT PD&R CARROLLTON, TX

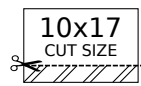

© 2019

WARNING
 DISCONNECT ALL POWER BEFORE SERVICING. ELECTRIC SHOCK HAZARD, CAN CAUSE INJURY OR DEATH. UNIT MUST BE GROUNDED IN ACCORDANCE WITH NATIONAL AND LOCAL CODES.
 FOR USE WITH COPPER CONDUCTORS ONLY. REFER TO UNIT RATING PLATE FOR MINIMUM CIRCUIT AMPACITY AND MAXIMUM OVERCURRENT PROTECTION SIZE.
 IF ANY WIRE IN THIS APPLIANCE IS REPLACED, IT MUST BE REPLACED WITH WIRE OF LIKE SIZE, RATING AND INSULATION THICKNESS.