



538230-01

01

02

03

04

05

06

07

08

09

10

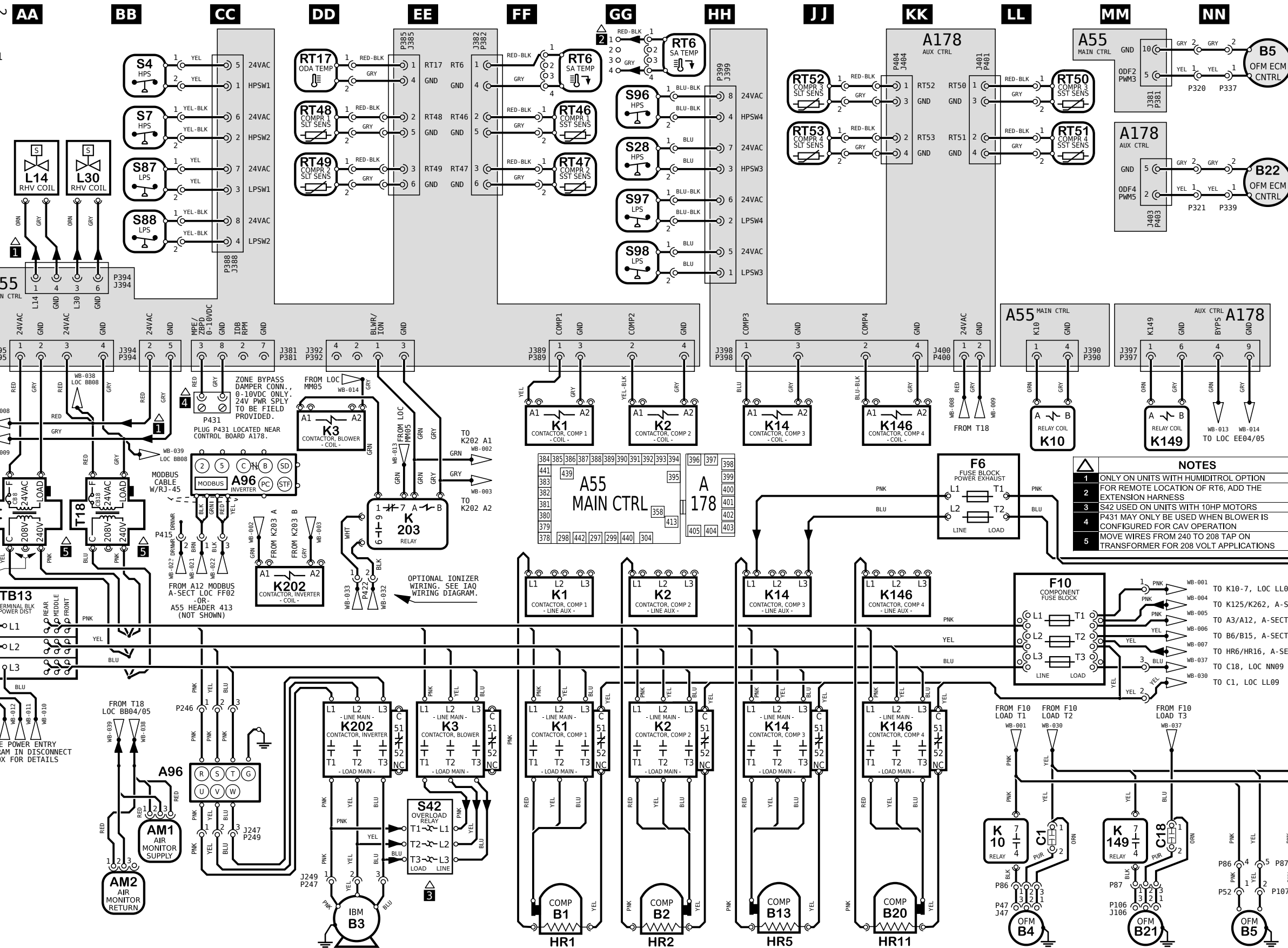

LOCATION	COMPONENT DESCRIPTION	
CC05/08	A96	CONTROL INVERTER, BLOWER
BB09	AM1, AM2	AIR MONITOR, SUPPLY/RETURN, IAQ-TVOC
FF/GG/JJ/KK10	B1, B2, B13, B20	COMPRESSOR 1, 2, 3, 4
DD10	B3	MOTOR, BLOWER
LL10, PP01/NN10	B4, B5	MOTOR, OUTDOOR FAN 1, 2
MM10, PP02/10	B21, B22	MOTOR, OUTDOOR FAN 3, 4
QQ09	B10, B11	MOTOR, EXHAUST FAN 1, 2
LL09	C1	CAPACITOR, OUTDOOR FAN 1
NN09	C18	CAPACITOR, OUTDOOR FAN 3
QQ09	C6, C8	CAPACITOR, EXHAUST FAN 1, 2
LL05	F6	FUSE, EXHAUST FAN
LL07	F10	FUSE, COMPONENT
FF/GG/JJ/KK10	HR1, HR2, HR5, HR11	HEATER, COMPRESSOR 1, 2, 3, 4
FF/GG05,06,08	K1, K2	CONTACTOR, COMPRESSOR 1, 2
JJ/KK05,06,08	K14, K146	CONTACTOR, COMPRESSOR 3, 4
DD05/EE08	K3	CONTACTOR, BLOWER
LL05/09	K10	RELAY, OUTDOOR FAN 1
MM05/09	K149	RELAY, OUTDOOR FAN 3
QQ07	K65, K231	RELAY, EXHAUST FAN 1, 2
DD06/08	K202	CONTACTOR, INVERTER
EE06	K203	RELAY, INVERTER CONTROL
AA02	L14, L30	VALVE, SOLENOID, REHEAT COIL 1, 2
GG01	RT6	SENSOR, A55 DISCHARGE (IMC)
DD01	RT17	SENSOR, OUTSIDE AIR TEMP
GG02, MM01/02	RT46, RT47, RT50, RT51	SENSOR, SAT. SUCT TEMP., COMP 1, 2, 3, 4
DD01/02, JJ01/02	RT48, RT49, RT52, RT53	SENSOR, SAT. LIQUID TEMP., COMP 1, 2, 3, 4
BB01/02, GG03/01	S4, S7, S28, S96	LIMIT, HI PRESS. SWITCH, COMP 1, 2, 3, 4
EE09	S42	OVERLOAD, RELAY, BLOWER MOTOR
BB02/08, GG03/02	S87, S88, S98, S97	SWITCH, LOW PRESS., COMP. 1, 2, 3, 4
AA06	T1	TRANSFORMER, CONTROL
BB06	T18	TRANSFORMER, CONTACTOR
AA07	TB13	TERMINAL STRIP, POWER DISTRIBUTION

NOTES	
1	ONLY ON UNITS WITH HUMIDITROL OPTION
2	FOR REMOTE LOCATION OF RT6, ADD THE EXTENSION HARNESS
3	S42 USED ON UNITS WITH 10HP MOTORS
4	P431 MAY ONLY BE USED WHEN BLOWER IS CONFIGURED FOR CAV OPERATION
5	MOVE WIRES FROM 240 TO 208 TAP ON TRANSFORMER FOR 208 VOLT APPLICATIONS

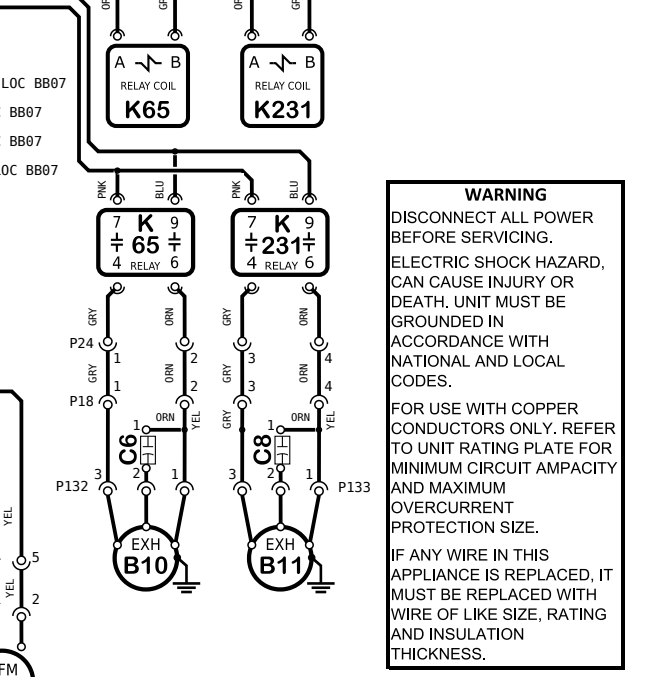
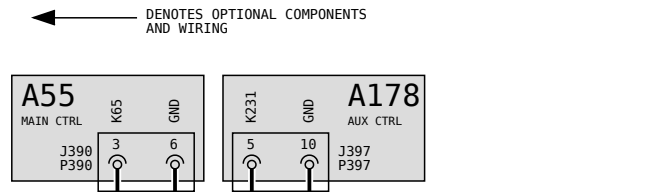

WARNING
DISCONNECT ALL POWER BEFORE SERVICING.
ELECTRIC SHOCK HAZARD, CAN CAUSE INJURY OR DEATH. UNIT MUST BE GROUNDED IN ACCORDANCE WITH NATIONAL AND LOCAL CODES.
FOR USE WITH COPPER CONDUCTORS ONLY. REFER TO UNIT RATING PLATE FOR MINIMUM CIRCUIT AMPACITY AND MAXIMUM OVERCURRENT PROTECTION SIZE.
IF ANY WIRE IN THIS APPLIANCE IS REPLACED, IT MUST BE REPLACED WITH WIRE OF LIKE SIZE, RATING AND INSULATION THICKNESS.

Model: LGT, LCT 210H - Y-VOLT
COOLING - MSAV WITH BYPASS - 4 COMPRESSORS 4 CONDENSER FANS

Voltage: 208-240V/3~60Hz (Y)
Supersedes: N/A Form No: 538230-01 Rev: 2

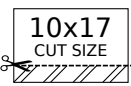
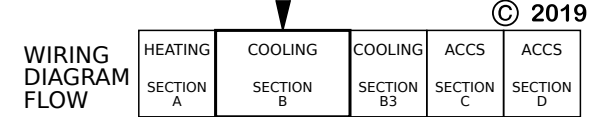

REV	EC NO.	DATE	BY	APVD	REVISION NOTE
---	CN-010356	06-20-2022	MXR6	JAL21	ORIGINATED AT PD&R CARROLLTON, TX
001	CN-010356E	07-26-2022	MXR6	JAL21	A) REVERSED HIGH VOLTAGE WIRING ON T18 TRANSFORMER.
002	CN-012015A	04-11-2024	MXR6	JAL21	UPDATED GND SYMBOL ON MOTORS AND INVERTER

© 2019



538230-01

01

02

03

04

05

06

07

08

09

10

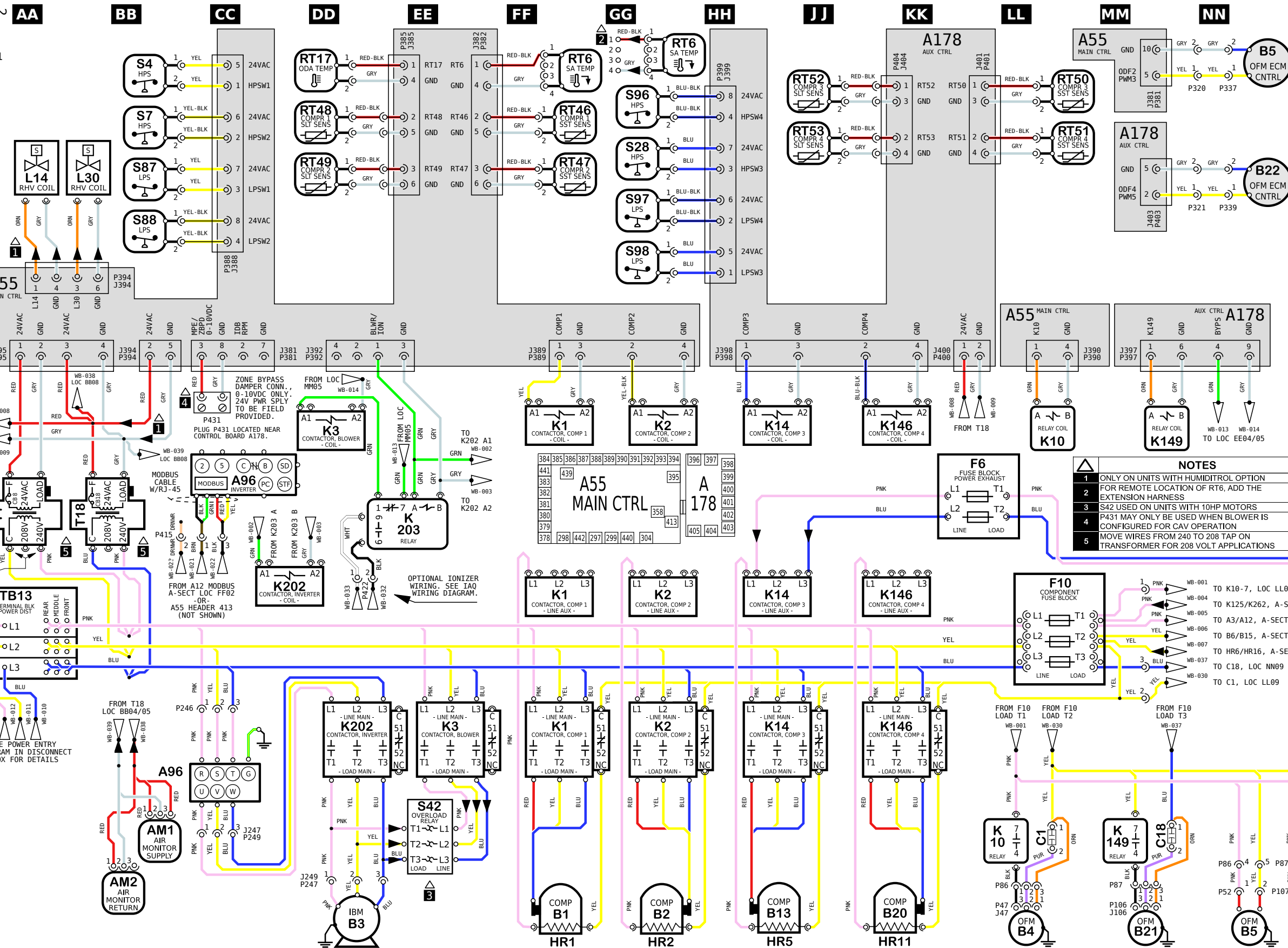

LOCATION	COMPONENT DESCRIPTION	
CC05/08	A96	CONTROL INVERTER, BLOWER
BB09	AM1, AM2	AIR MONITOR, SUPPLY/RETURN, IAQ-TVOC
FF/GG/JJ/KK10	B1, B2, B13, B20	COMPRESSOR 1, 2, 3, 4
DD10	B3	MOTOR, BLOWER
LL10, PP01/NN10	B4, B5	MOTOR, OUTDOOR FAN 1, 2
MM10, PP02/10	B21, B22	MOTOR, OUTDOOR FAN 3, 4
QQ09	B10, B11	MOTOR, EXHAUST FAN 1, 2
LL09	C1	CAPACITOR, OUTDOOR FAN 1
NN09	C18	CAPACITOR, OUTDOOR FAN 3
QQ09	C6, C8	CAPACITOR, EXHAUST FAN 1, 2
LL05	F6	FUSE, EXHAUST FAN
LL07	F10	FUSE, COMPONENT
FF/GG/JJ/KK10	HR1, HR2, HR5, HR11	HEATER, COMPRESSOR 1, 2, 3, 4
FF/GG05,06,08	K1, K2	CONTACTOR, COMPRESSOR 1, 2
JJ/KK05,06,08	K14, K146	CONTACTOR, COMPRESSOR 3, 4
DD05/EE08	K3	CONTACTOR, BLOWER
LL05/09	K10	RELAY, OUTDOOR FAN 1
MM05/09	K149	RELAY, OUTDOOR FAN 3
QQ07	K65, K231	RELAY, EXHAUST FAN 1, 2
DD06/08	K202	CONTACTOR, INVERTER
EE06	K203	RELAY, INVERTER CONTROL
AA02	L14, L30	VALVE, SOLENOID, REHEAT COIL 1, 2
GG01	RT6	SENSOR, A55 DISCHARGE (IMC)
DD01	RT17	SENSOR, OUTSIDE AIR TEMP
GG02, MM01/02	RT46, RT47, RT50, RT51	SENSOR, SAT. SUCT TEMP, COMP 1, 2, 3, 4
DD01/02, JJ01/02	RT48, RT49, RT52, RT53	SENSOR, SAT. LIQUID TEMP, COMP 1, 2, 3, 4
BB01/02, GG02/01	S4, S7, S28, S96	LIMIT, HI PRESS. SWITCH, COMP 1, 2, 3, 4
EE09	S42	OVERLOAD, RELAY, BLOWER MOTOR
BB02/08, GG03/02	S87, S88, S98, S97	SWITCH, LOW PRESS., COMP. 1, 2, 3, 4
AA06	T1	TRANSFORMER, CONTROL
BB06	T18	TRANSFORMER, CONTACTOR
AA07	TB13	TERMINAL STRIP, POWER DISTRIBUTION

NOTES	
1	ONLY ON UNITS WITH HUMIDITROL OPTION
2	FOR REMOTE LOCATION OF RT6, ADD THE EXTENSION HARNESS
3	S42 USED ON UNITS WITH 10HP MOTORS
4	P431 MAY ONLY BE USED WHEN BLOWER IS CONFIGURED FOR CAV OPERATION
5	MOVE WIRES FROM 240 TO 208 TAP ON TRANSFORMER FOR 208 VOLT APPLICATIONS

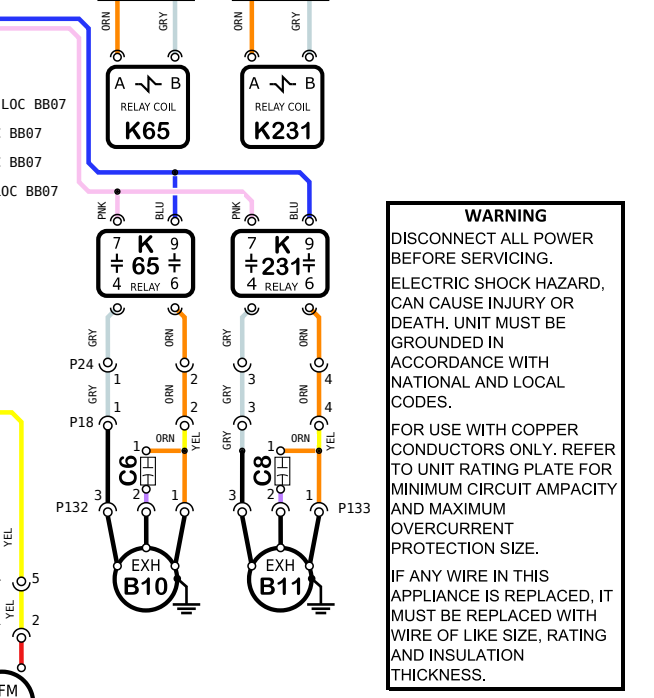
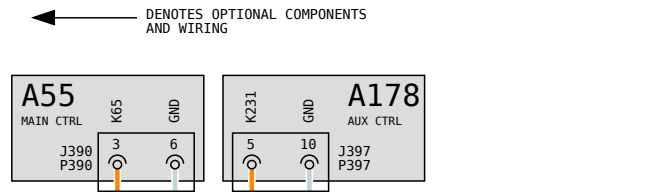

Model: LGT, LCT 210H - Y-VOLT
 COOLING - MSAV WITH BYPASS - 4 COMPRESSORS 4 CONDENSER FANS

Voltage: 208-240V/3~/60Hz (Y)
 Supersedes: N/A Form No: 538230-01 Rev: 2

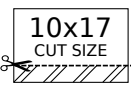
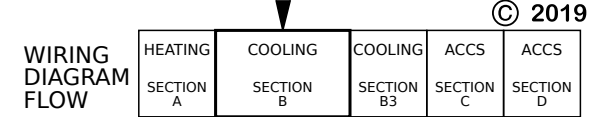

REV	EC NO.	DATE	BY	APVD	REVISION NOTE
---	CN-010356	06-20-2022	MXR6	JAL21	ORIGINATED AT PD&R CARROLLTON, TX
001	CN-010356E	07-26-2022	MXR6	JAL21	A) REVERSED HIGH VOLTAGE WIRING ON T18 TRANSFORMER.
002	CN-012015A	04-11-2024	MXR6	JAL21	UPDATED GND SYMBOL ON MOTORS AND INVERTER

© 2019