

SUBMITTAL DATA - OUTDOOR UNIT

VRB336L4M-3Y

VRB120L4M-3Y + VRB120L4M-3Y+VRB096L4M-3Y

VRF Heat Recovery

Job: _____
 Location: _____
 Schedule No.: _____
 System Designation: _____

Engineer: _____
 Architect: _____
 Location: _____
 Date: _____

Heat Recovery Outdoor Unit

For:	Reference	Approval	Review	Construction
------	-----------	----------	--------	--------------

FEATURES

- Split coil heat exchanger
- Dual hinged electrical boxes for ease of maintenance
- High-efficiency vapor injection inverter compressor
- Intelligent Duty Cycle operation
- Night Silent operation
- Hinged service doors
- Built-in service console
- Built-in base pan heater
- Heating Operation down to -22F
- Low Ambient Cooling down to -10F w/ kit

WARRANTY

- Compressor - 10-year limited warranty
 - All other components - 10-year limited warranty
- *See warranty for details

SPECIFICATIONS

PERFORMANCE

Cooling Capacity ¹ (Btu/h)	Nominal	336,000
	Rated ²	320,000
EER	Ducted	10.5
	Non-Ducted	10.6
IEER	Ducted	19.8
	Non-Ducted	19.9
SCHE	Ducted	26.6
	Non-Ducted	28.0
Heating Capacity ¹ (Btu/h)	Nominal	378,000
	Rated ²	360,000
COP47	Ducted	3.65
	Non-Ducted	3.48
COP17	Ducted	2.47
	Non-Ducted	2.33

ELECTRICAL DATA

Power Supply (Volts/Phase/Hertz)	208-230/3/60
Minimum Circuit Ampacity (A)	(2) 82.6+75
Maximum Overcurrent Protection (A)	(2) 90+80
Compressor RLA (A)	(2) 33/33+29.6/29.6
Number of Compressors	2+2+2
Outdoor Fan Power Input (W)	(3) 1200/1200
Outdoor Fan FLA (A)	(3) 4.0/4.3

GENERAL DATA

Connection Ratio	50% to 130%
Maximum Number of Indoor Units	61
Refrigerant Type	R-410A
Factory Refrigerant Charge (each unit)	23.8 lbs.

NOTES

1. Cooling and Heating capacity data is rated at the following conditions:
 Cooling: 80°FDB / 67°FWB Indoor, 95°FDB Outdoor
 Heating: 70°FDB Indoor, 47°FDB / 43°FWB Outdoor.
2. Complies with AHRI 1230-2014 testing standards
3. Operating Voltage Range 175V to 263V
4. To achieve cooling lower than 5°F a Low ambient hood must be installed. This is purchased as an accessory.
5. A local 115V power outlet is available as an accessory to provide local power for maintenance.



DIMENSIONS		VRB120	VRB120	VRB096
Unit	Height	72	72	72
Dimensions (in)	Width	68-1/2	68-1/2	68-1/2
	Depth	32-5/8	32-5/8	32-5/8

Main System Piping (in)

Liquid Pipe Connection	3/4	3/4	3/4
Gas Pipe Connection	1-1/4	1-1/4	1-1/4

Balancing Pipework between Modules (in)

L.P. Gas Balance Pipe Connection	1-1/4	1-1/4	1-1/4
H.P. Gas Balance Pipe Connection	3/4	3/4	3/4
Oil Balance Pipe Connection	5/16	5/16	5/16
Unit Net Weight (lb)	1093	1093	1093



NOTE - Due to Lennox' ongoing commitment to quality, Specifications, Ratings and Dimensions subject to change without notice and without incurring liability.

Improper installation, adjustment, alteration, service or maintenance can cause property damage or personal injury. Installation and service must be performed by a qualified installer and servicing agency.

SUBMITTAL DATA - OUTDOOR UNIT
VRB336L4M-3Y
VRB120L4M-3Y + VRB120L4M-3Y+VRB096L4M-3Y
VRF Heat Recovery

DIMENSIONAL DRAWINGS - INCHES (MM)

CORNER WEIGHTS								CENTER OF GRAVITY				
Model No.	AA		BB		CC		DD		EE		FF	
	lbs.	kg	lbs.	kg	lbs.	kg	lbs.	kg	in.	mm	in.	mm
VRB096L4, VRB120L4	173	80	266	122	332	153	323	148	37-1/2	953	12	305

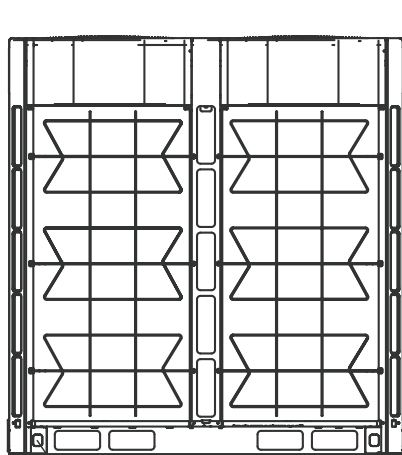
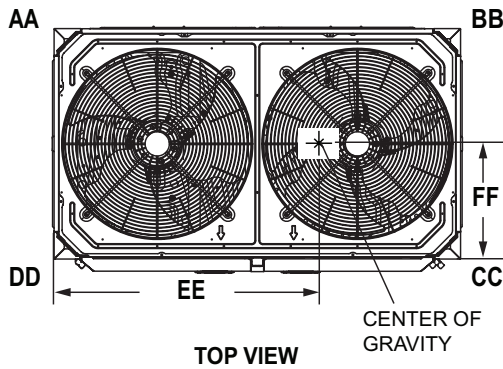

LAG BOLT DESIGNATION (BOTH SIDES) (TO ACCESS LAG BOLT)

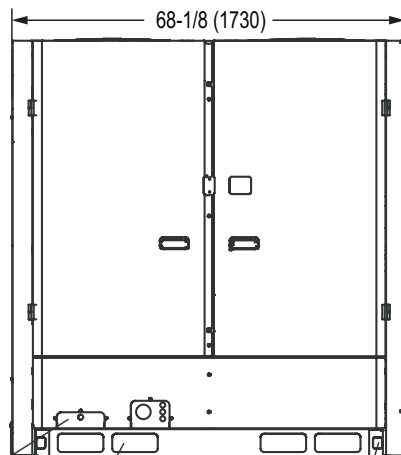

PARELLEL MODULE PIPING KNOCKOUT
FORKLIFT SLOT (BOTH SIDES) (REFIRGERANT LINE PATH)
LIFTING HOLES (BOTH SIDES) (FOR RIGGING)

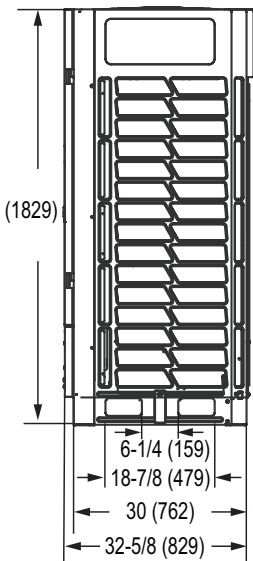

SIDE VIEW

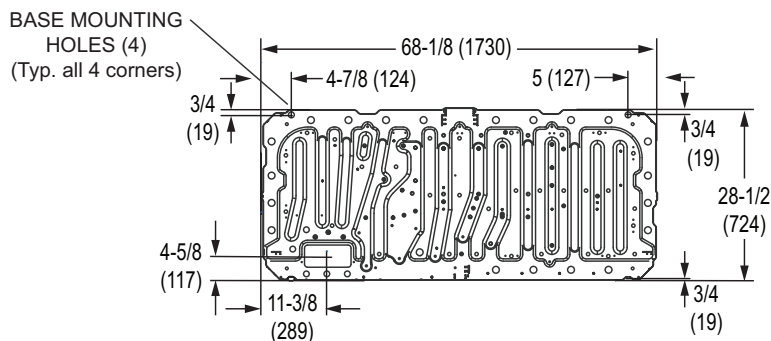

BASE PAN VIEW

NOTE - Due to Lennox' ongoing commitment to quality, Specifications, Ratings and Dimensions subject to change without notice and without incurring liability. Improper installation, adjustment, alteration, service or maintenance can cause property damage or personal injury. Installation and service must be performed by a qualified installer and servicing agency.

MULTI-MODULE INFORMATION

Multi-Module Dimensions

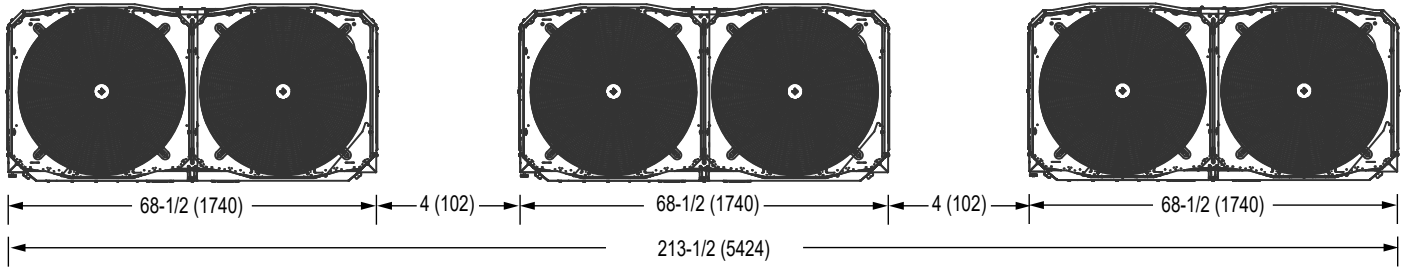

NOTE - All the outdoor units manifolded together should be installed at the same elevation.

TOP VIEW

Multi-Module Power

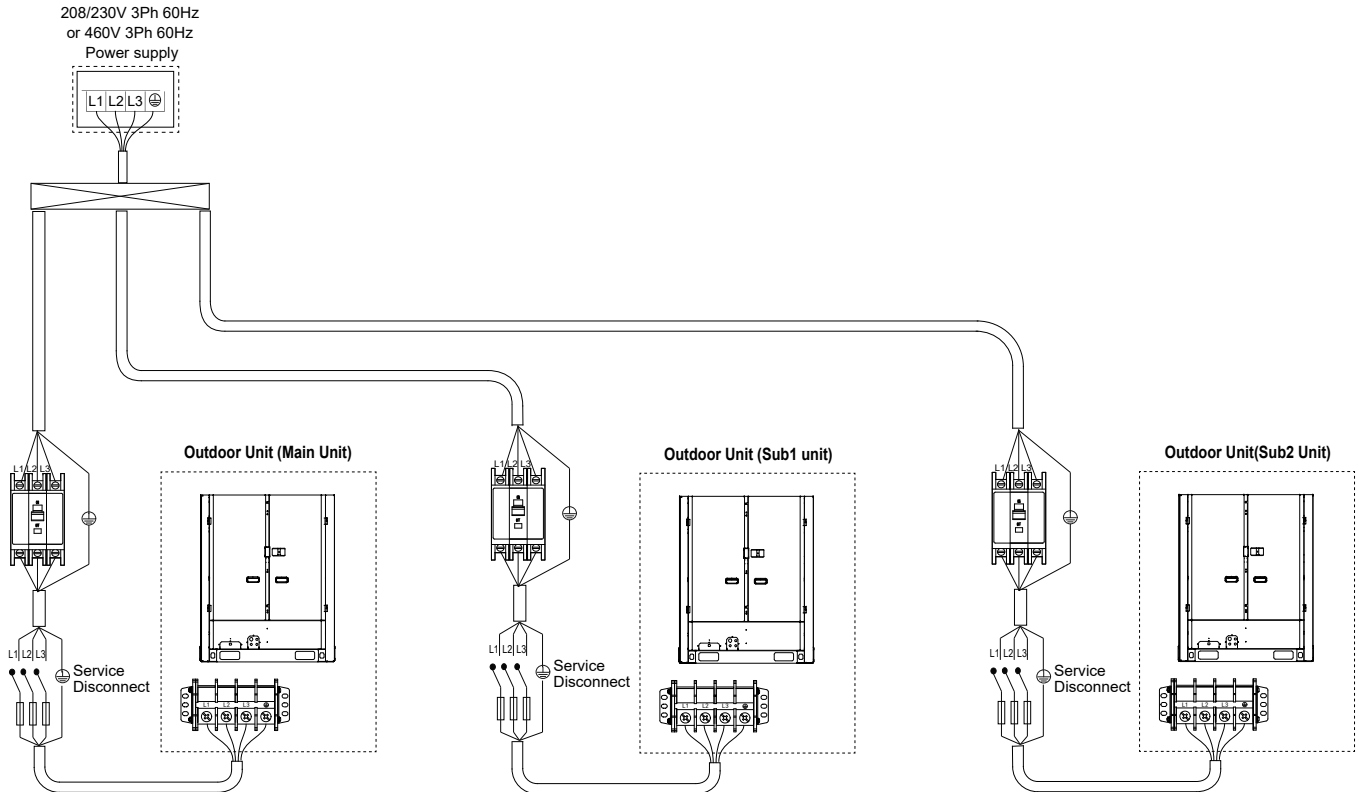

See page 1 for electrical data.
 Total system MCA is calculated by adding the MCA value of each module together to get the total system MCA.
 Total system MOP is calculated by adding the MOP value of each module together to get the total system MCA.