



ELECTRIC HEAT KITS

507003-05
11/2024
Supersedes 507003-04

See unit nameplate for manufacturer's name and address.

EHA150/360 ELECTRIC HEAT

INSTALLATION INSTRUCTIONS FOR EHA150/360 ELECTRIC HEAT ASSEMBLIES USED WITH LC/LH/KC/KH 156/360 UNITS

Shipping and Packing List

Package 1 of 1 contains:

- 2- Electric heat assemblies*
- 1- Electric heat control module (used on KC/KH only)
- 1- TB2 terminal block

Electric heat pigtails (quantity varies by model)

- 1- Bag assembly containing:
 - Wiring diagram stickers (qty. 1, 2, 3, or 4)
 - 20- Screws
- 1- Box assembly containing (used on KC/KH units without hinges only):
 - 2- Electric heat door frames
 - 2- Electric heat doors
 - 4- Door hinges

**When replacing an existing electric heat assembly of the same size, it is not necessary to replace the rest of the parts found in this kit.*

Inspect package upon receiving. If damage is found, contact last carrier immediately.

F4 Fuse Block

Fuse block assembly (F4) is furnished with the unit. The fuse block is required in single point power installations only.

Terminal Block

TB2 in this kit replaces any factory-installed TB2. TB2 in this kit also replaces any factory-installed S48 or CB10 larger than 80amp.

⚠ WARNING

Improper installation, adjustment, alteration, service or maintenance can cause property damage, personal injury or loss of life. Installation and service must be performed by a licensed professional HVAC installer or equivalent, service agency, or the gas supplier.

⚠ CAUTION

As with any mechanical equipment, contact with sharp sheet metal edges can result in personal injury. Take care while handling this equipment and wear gloves and protective clothing.

Application

EHA150, 156, 240 & 360 electric heat sections are used as primary heaters for packaged cooling units and as a secondary heat source for packaged heat pump units. See TABLE 2 for match-ups. Two electric heat assemblies are used in 156 through 360 units.

Requirements

The EHA 60 Hz series heaters are CSA and ETL design certified. The EHA 50 Hz series heaters are CE compliant. Installation of electric heaters must conform with standards of the National Fire Protection Association (NFPA) "Standard for Installation of Air Conditioning and Ventilation Systems NFPA No. 90A," "Standard for the Installation of Residence Type Warm Air Heating and Air Conditioning Systems NFPA No. 90B;" in Canada, CSA C22.1 Canadian Electrical Code — Part I and all applicable CSA requirements; manufacturer's installation instructions and local municipal building codes. Heaters are approved for clearances to combustible materials as listed on heater rating plate.

Accessibility and service clearances must take precedence over fire protection clearances. All wiring must conform with local building codes and the current National Electric Code (NEC) ANSI-C1 and in Canada, CSA C22.1 Canadian Electrical Code —Part I and the applicable CSA requirements.

Installation

- 1 - Disconnect all power to unit
- 2 - Remove or open unit heat and compressor access panels. Remove screws and discard rectangular vestibule covers. See unit installation instruction dimension page.
- 3 - **LC/LH/KC/KH 156 Units -**
Knock down two tabs in unit heat sections. See FIGURE 1.

- 4 - Insert electric element heat assembly into rectangular vestibule opening and secure assembly using screws provided. See FIGURE 1.
- 5 - **KC/KH Units Only -**
Install electric heat control module in control area as shown in FIGURE 2. Secure with #8 thread forming screws (provided).
- 6 - **Units Without CB10 or S48 Only -**
Replace the unit terminal block TB2 with the terminal block provided in kit.
- 7 - Place appropriate electric heat wiring diagram on the inner side of compressor access panel. One, two, three, or four diagrams are provided with each kit.
See TABLE 1 to determine which diagram to use.

TABLE 1

Unit	Diagram
LCH	Energence listed in title block. LCH units will be equipped with either an M2 or M3 Unit Controller. M2 or M3 will be printed on the bottom of the Unit Controller near the SBUS connector. On units equipped with an M2 Unit Controller, use the diagram which does NOT have A178 in the key list. On units equipped with an M3 Unit Controller, use the diagram which has A178 in the key list.
LCM/ LCT/LHT/ LCX	Has A178 in key list; no unit name or model number in title block.
KC/KH	DL2 & DL5

TABLE 2

Catalog No./ Part No	Unit Voltage	Output	Model
30U62/604503-69	208/240V-3ph	15kW	LCT / LHT / KCC / KHC
30U63/604503-70	460V-3ph		
30U64/604503-71	575V-3ph		
30U65/604503-72	208/240V-3ph	30 kW	LCT / KCC
30U66/604503-73	460V-3ph		
30U67/604503-74	575V-3ph		
30U68/604503-75	208/240V-3ph		LHT / KHC
30U69/604503-76	460V-3ph		
30U70/604503-77	575V-3ph		
30U71/604503-78	208/240V-3ph	45 kW	
30U72/604503-79	460V-3ph		
30U73/604503-80	575V-3ph		
30U74/604503-81	208/240V-3ph		LHT / KHC
30U75/604503-82	460V-3ph		
30U76/604503-83	575V-3ph		
30U77/604503-84	208/240V-3ph	60 kW	
30U78/604503-85	460V-3ph		
30U79/604503-86	575V-3ph		
30U80/604503-87	208/240V-3ph		LHT / KHC
30U81/604503-88	460V-3ph		
30U82/604503-89	575V-3ph		
30U83/604503-90	208/240V-3ph	90 kW	
30U84/604503-91	460V-3ph		
30U85/604503-92	575V-3ph		

(2) Two electric heat assemblies.

ELECTRIC HEAT INSTALLATION
(EHA360-45 SHOWN IN KC/KH UNIT)

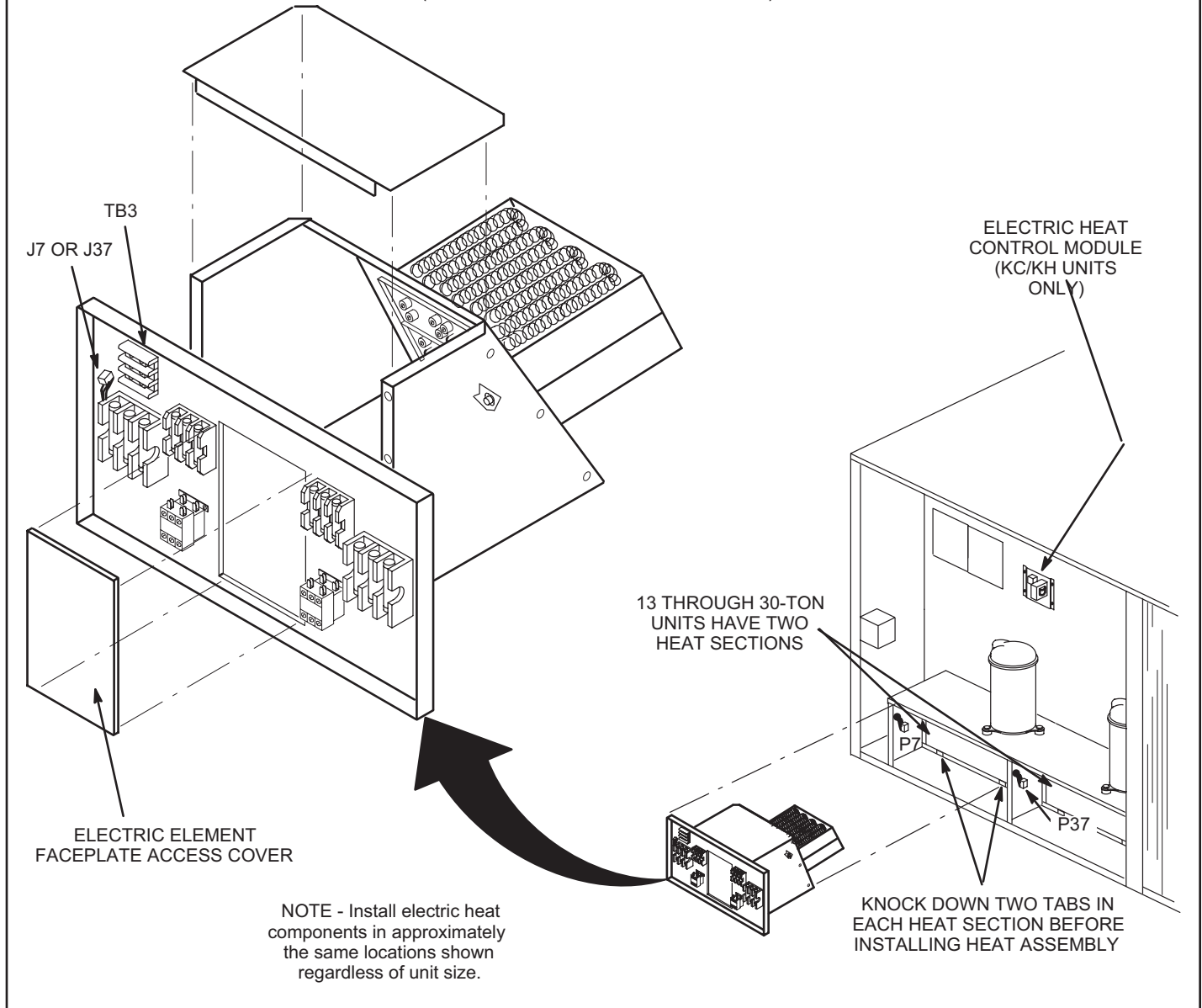

FIGURE 1

Electrical Connections

Wiring must conform to local codes and NEC/CEC. Refer closely to wiring diagram in this instruction and the following information: If electric heat assembly is being installed in an existing unit, a change in power supply wiring and disconnect switch or circuit breaker may be required. Remove the original supply wires or disconnect at power source. Refer to heater nameplate for minimum circuit ampacity and maximum fuse size.

⚠ WARNING



Electric shock hazard. Can cause injury or death. Before attempting to perform any service or maintenance, turn the electrical power to unit OFF at disconnect switch(es). Unit may have multiple power supplies.

KC/KH Units Control Wiring

Refer to FIGURE 2.

NOTE - Install electric heat control module before making wire connections. See Installation section.

- 1 - Connect wire from electric heat control assembly marked GND to grounding tab.
- 2 - Connect wire marked "TB13-L2" to "L2" of TB13 terminal block.
- 3 - Connect wire marked "TB13-L3" to "L3" of TB13 terminal block.
- 4 - Remove the jumper plug from J2; connect J2 to P2 plug located near J2.
- 5 - Route wires marked "P7" and "P37" to the location shown in FIGURE 2 and secure harness with wire ties provided.
- 6 - Connect wires marked "J7" and "J37" in electric heat assemblies to pigtail wires marked "P7" and "P37" from kit harness.

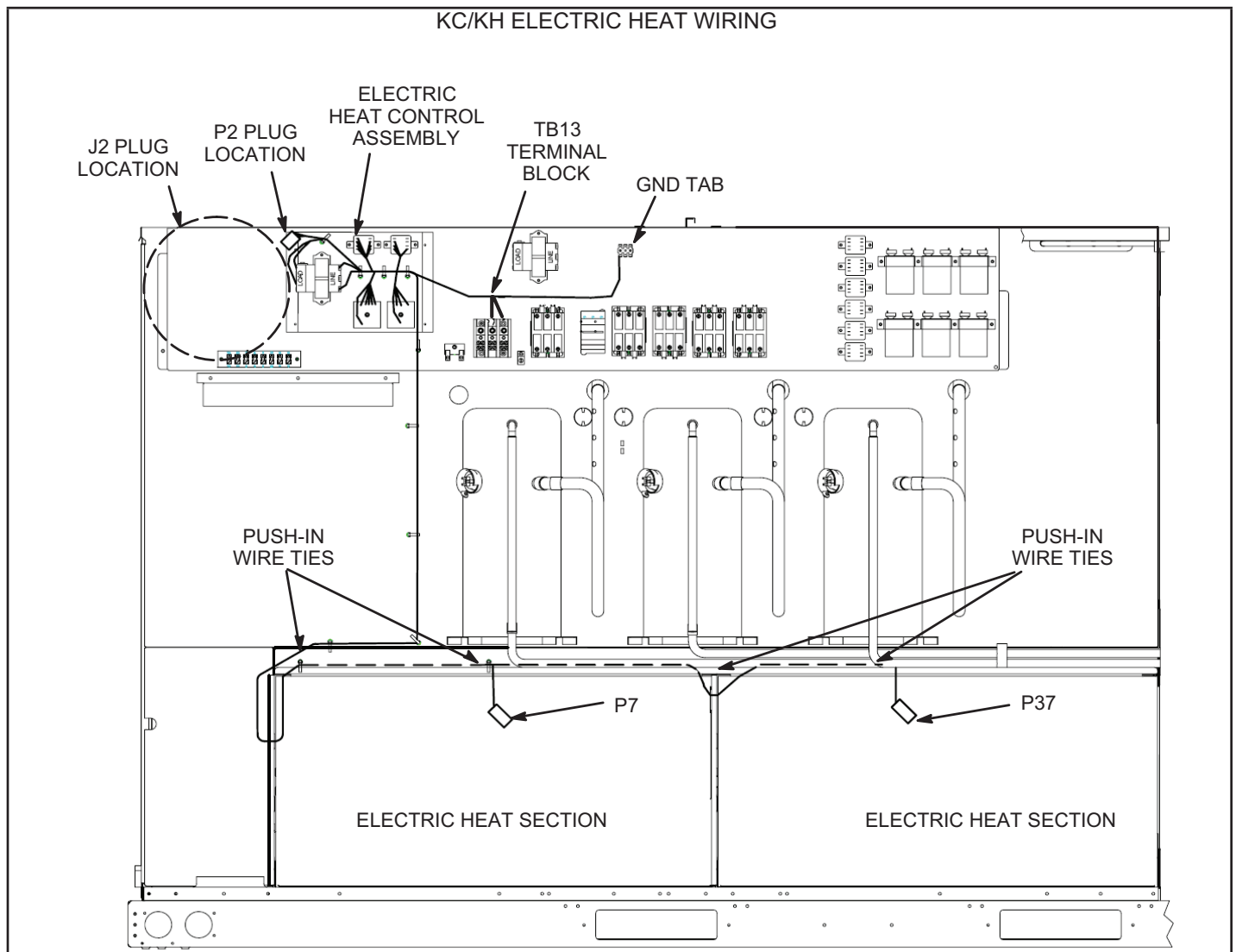

FIGURE 2

LC/LH Units Control Wiring

Refer to FIGURE 3 or FIGURE 4.

- 1 - Locate and disconnect J7 and J37 jumper plug from harness. See FIGURE 3.
- 2 - Cut wire ties that bundle P7 and J37 harnesses; do not damage wires.
- 3 - Route P37 to the right heat section as shown in FIGURE 3 or FIGURE 4.
- 4 - Connect electric heat assembly wires marked "J7" and "J37" to pigtail wires marked "P7" and "P37".

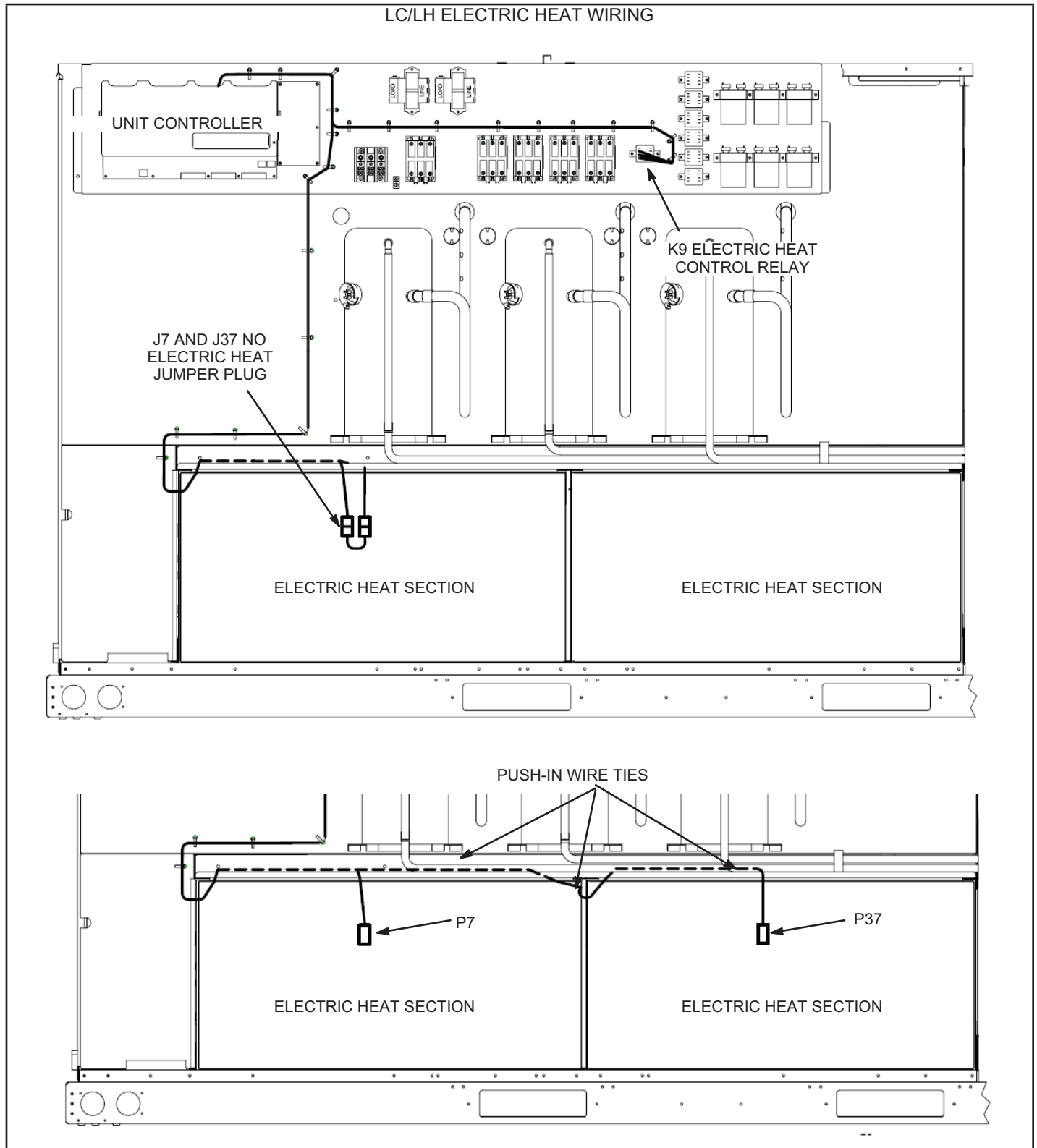

FIGURE 3

LCM ELECTRIC HEAT WIRING

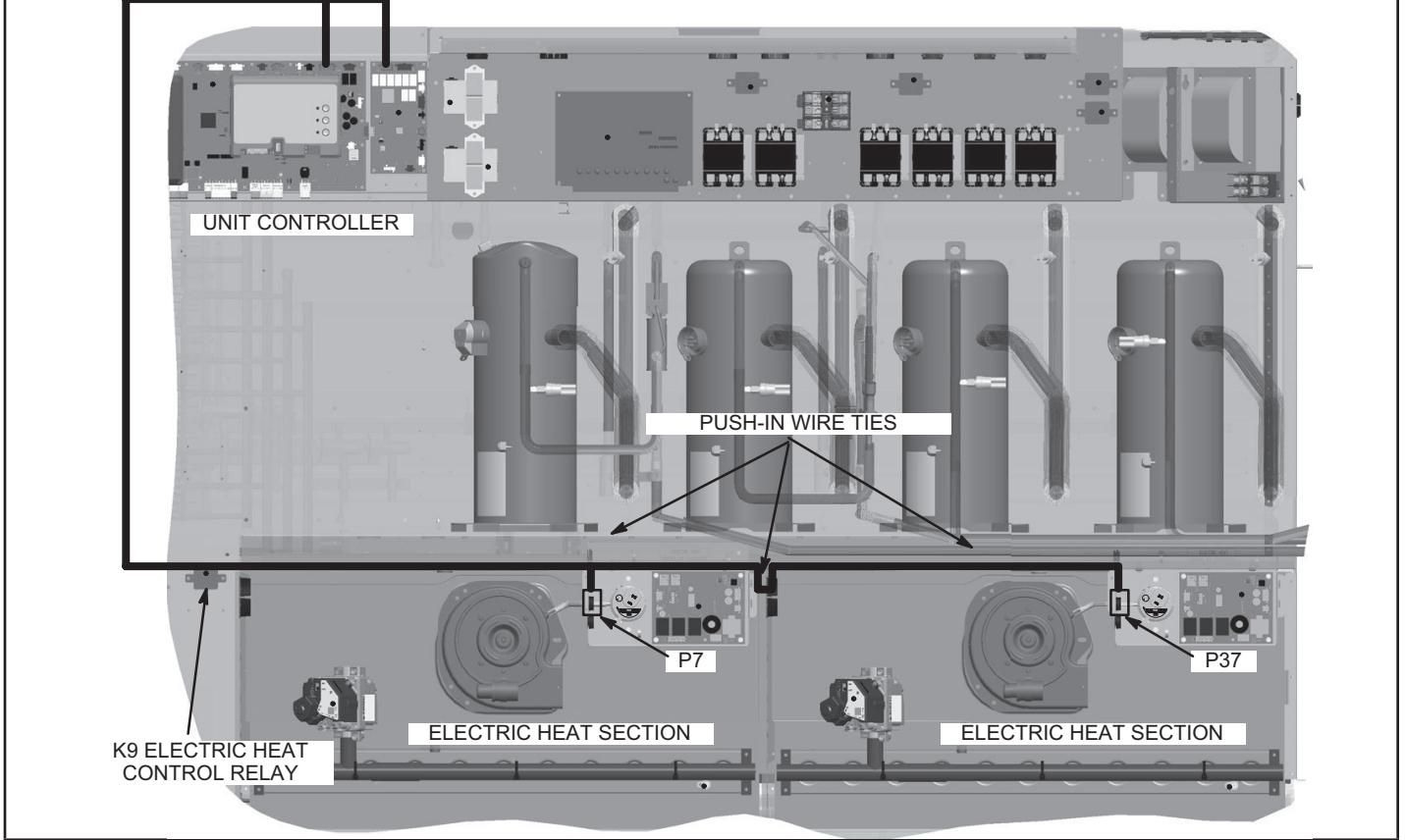

FIGURE 4

Power Wiring

- 1 - Review heater installed nameplate for MCA values and enlarge power entry knockouts as needed.
- 2 - Connect electric heat power wiring to unit terminal block TB2 as shown in FIGURE 5. Also see FIGURE 6 through FIGURE 8 depending on the options included on the electric heat assembly.

- 3 - Route the other side of the electric heat power wiring through the bottom of the disconnect box and the side of the electric heat compartment. Connect power wiring to electric heat fuse block F3 or electric heat terminal block TB3. See FIGURE 4.

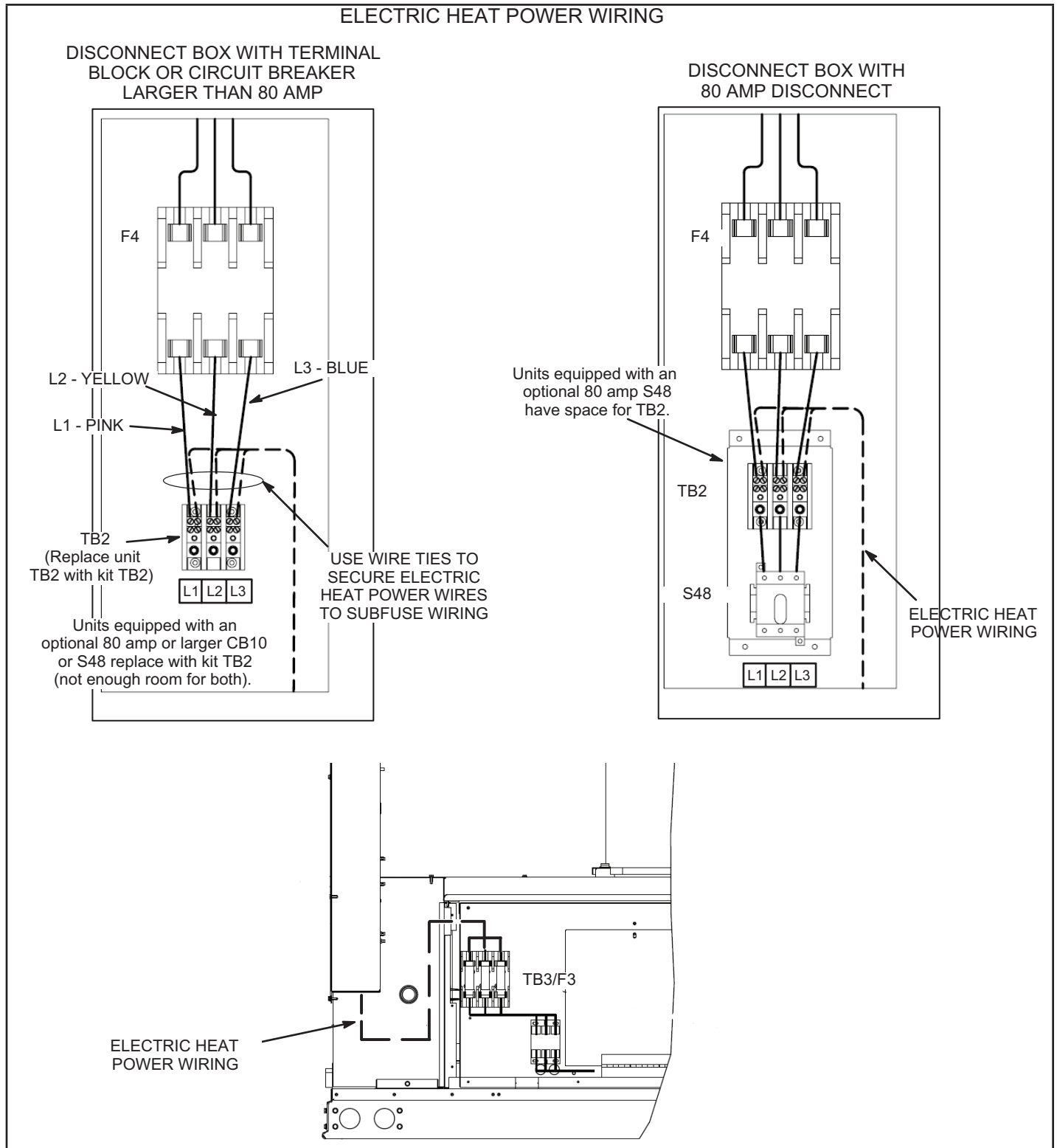

FIGURE 5

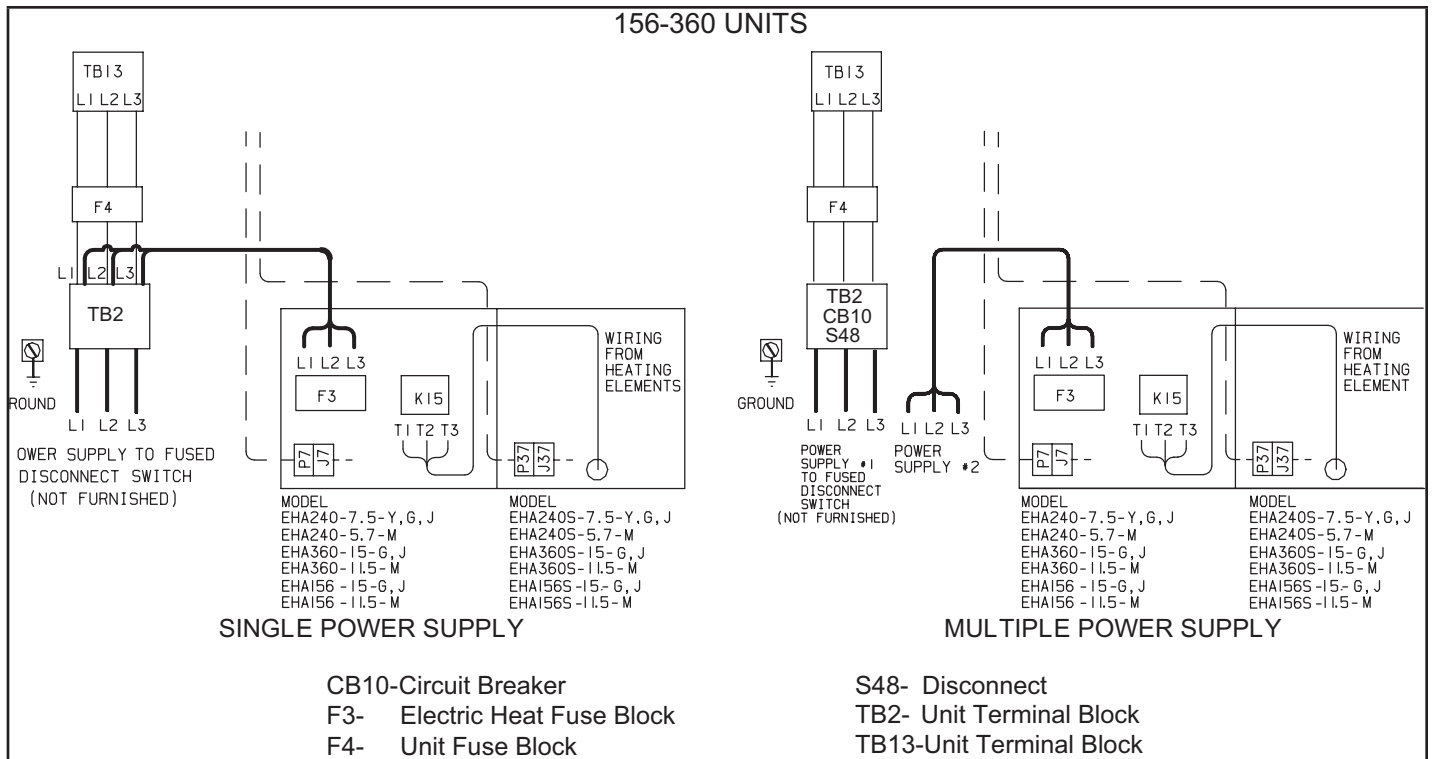

FIGURE 6

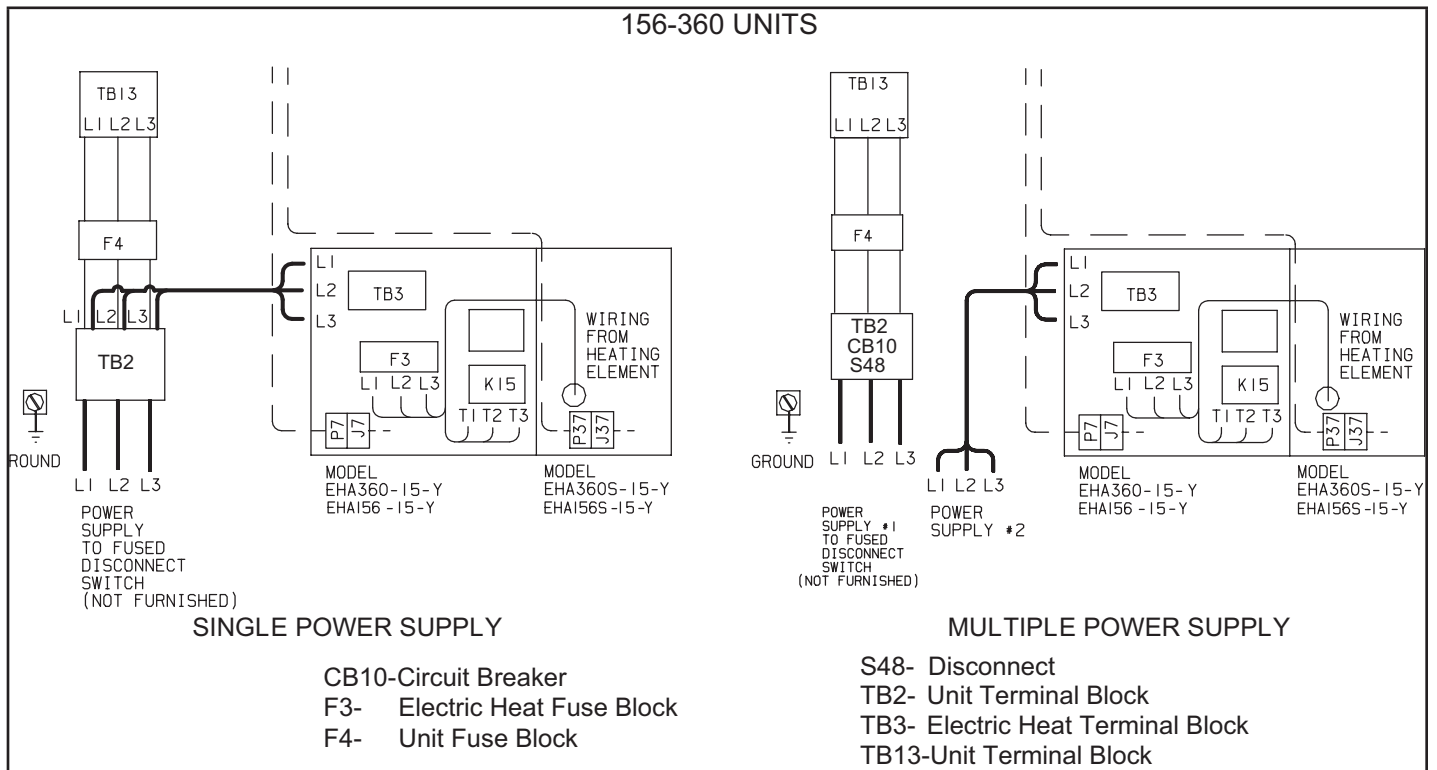
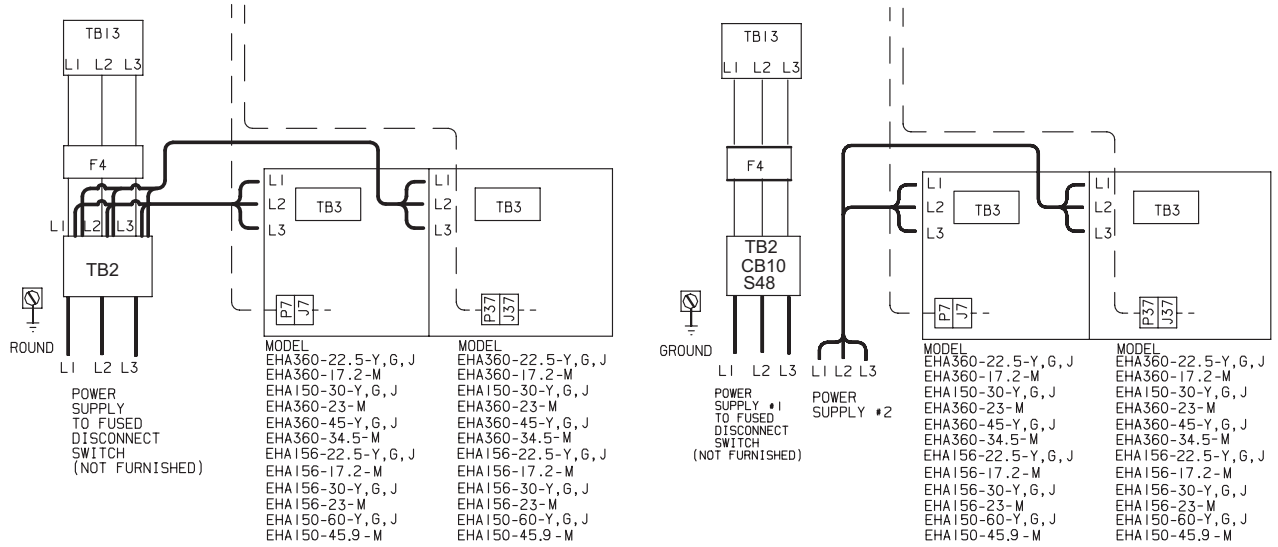

FIGURE 7

156-360 UNITS



SINGLE POWER SUPPLY

MULTIPLE POWER SUPPLY

CB10-Circuit Breaker
 F3- Electric Heat Fuse Block
 F4- Unit Fuse Block

S48- Disconnect
 TB2- Unit Terminal Block
 TB3- Electric Heat Terminal Block
 TB13-Unit Terminal Block

FIGURE 8

TABLE 3

Electric Heat Model ¹	Fuses ²			
	Qty	Class	Amps	Volt
EHA150-30-2Y	6	RK5	50	250
EHA150-30-2G	6	RK5	25	600
EHA150-30-2J	6	RK5	20	600
EHA156-15-1Y	6	RK5	60	250
EHA156-15-1G	3	RK5	50	600
EHA156-15-1J	3	RK5	40	600
EHA156-22.5-1Y	3	RK5	50	250
	3	RK5	25	250
EHA156-22.5-1G	3	RK5	25	600
	3	RK5	15	600
EHA156-22.5-1J	3	RK5	20	600
	3	RK5	10	600
EHA156-30-1Y	6	RK5	50	250
EHA156-30-1G	6	RK5	25	600
EHA156-30-1J	6	RK5	20	600

¹ Refer to Electric Heat Assembly nameplate

² Use Time Delay Type

TABLE 4

Electric Heat Model ¹	Fuses ²			
	Qty	Class	Amps	Volt
EHA240-7.5-2Y	3	RK5	50	250
EHA240-7.5-2G	3	RK5	25	600
EHA240-7.5-2J	3	RK5	20	600
EHA360-15-2Y	6	RK5	60	250
EHA360-15-2G	3	RK5	50	600
EHA360-15-2J	3	RK5	40	600
EHA360-22.5-2Y	3	RK5	50	250
	3	RK5	25	250
EHA360-22.5-2G	3	RK5	25	600
	3	RK5	15	600
EHA360-22.5-2J	3	RK5	20	600
	3	RK5	10	600
EHA360-45-2Y	3	RK5	50	250
	6	RK5	60	250
EHA360-45-2G	3	RK5	25	600
	3	RK5	50	600
EHA360-45-2J	3	RK5	20	600
	3	RK5	40	600

¹ Refer to Electric Heat Assembly nameplate

² Use Time Delay Type

Electric Heat Door Assembly

KC/KH Units With Non-Hinged Access Doors Only

- 1 - Install electric heat door assembly after electric heat assembly and wiring is completed.
- 2 - Remove the front middle and right side mullions as shown in FIGURE 9.

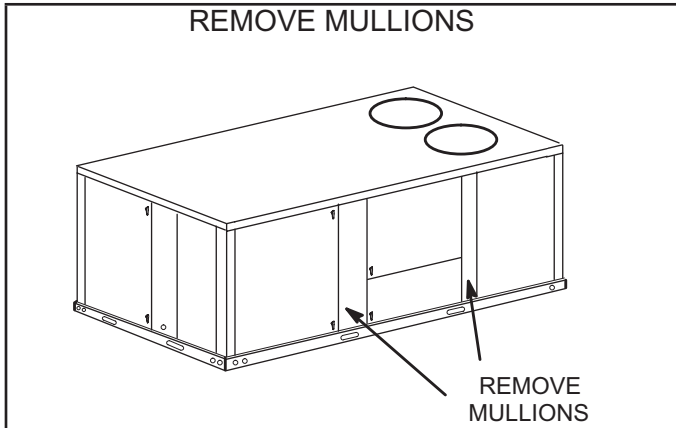

FIGURE 9

- 3 - Remove the screw installed in the upper left corner of the left electric heat section. Position electric heat door assemblies in the electric heat openings as shown in FIGURE 10. Make sure the doors open in the directions indicated.
- 4 - Secure each door from the inside of the compartment as shown in FIGURE 10. Secure with #10 sheet metal screws provided. Replace the screw which was removed in the previous step.
- 5 - Make sure the hinged doors open and close properly. Adjust hinges if necessary.

Blower Speed Requirements

Electric heater applications require specific blower air volumes. Refer to blower tables in the unit installation instruction for start-up.

NOTE - Minimum air requirements are shown in tables; do not set CFM lower than minimum CFM listed.

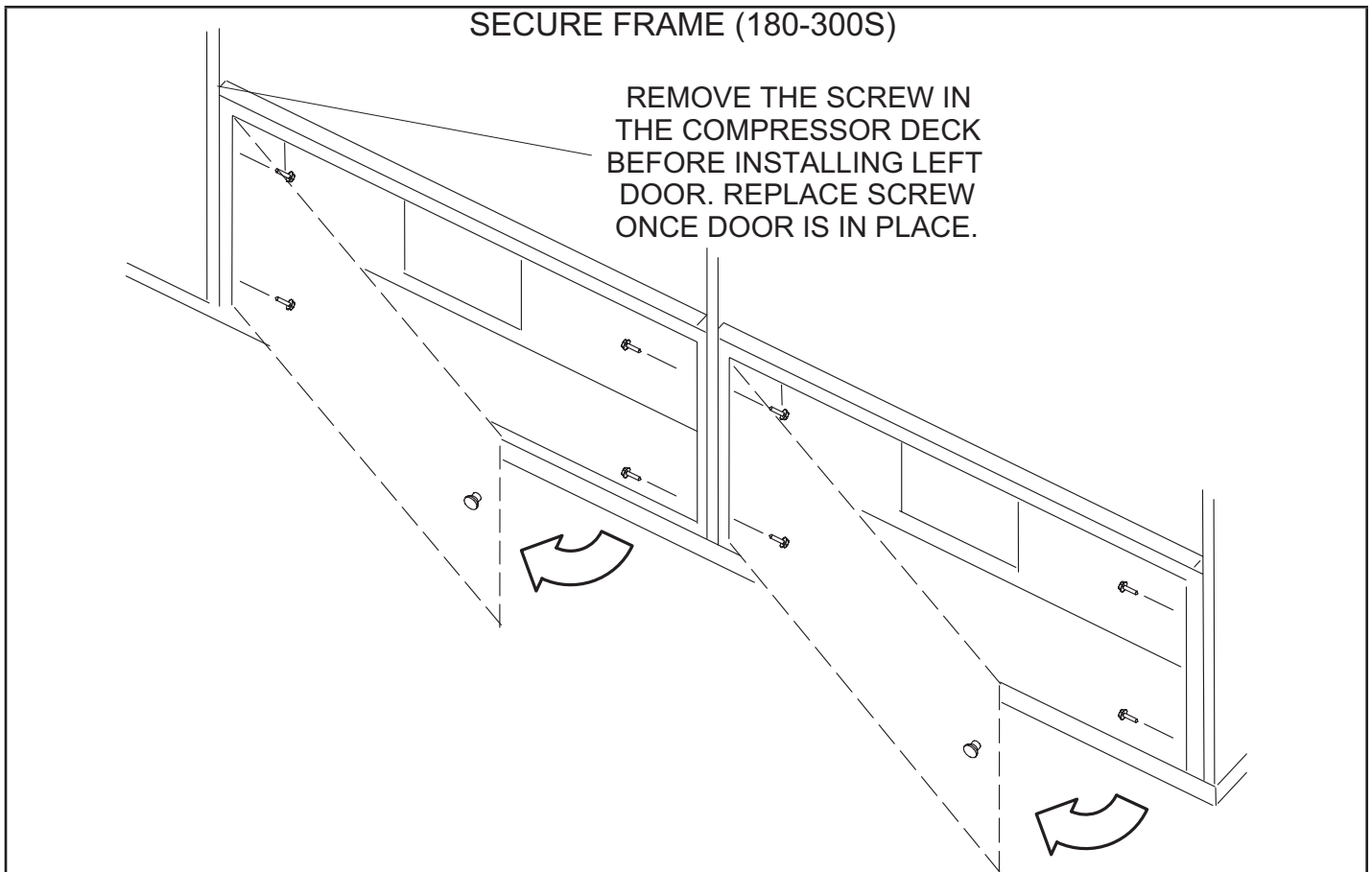

FIGURE 10

Set Unit Controller - LC/LH Units

Set the Unit Controller using one of the following menus. M2, M3, or M4 is printed near the bottom of the Unit Controller by the SBUS connector on LCH units and near the seven-segment display on LCM, LCT, LHT, and LCX units. Refer to the Unit Controller manual provided with each rooftop unit.

M2 Unit Controller

Use this menu to enable the appropriate number of electric heat stages.

SETTINGS > INSTALL > ELECTRIC HEAT STAGES

M3 Unit Controller

The Unit Controller configuration I.D. must be set to identify that electric heat has been installed.

NOTE - The number of electric heat stages do not have to be entered with version 08 and later

- 1 - Use the Unit Controller keypad to enter the following menu:

MAIN MENU > SETUP > INSTALL

- 2 - Press SAVE until CONFIGURATION ID 2 appears. Change the 9th digit to specify the electric heat installed as follows:

N = No electric heat

E = 15 kW

J = 30 kW

K = 45 kW

L = 60 kW

P = 90 kW

S = 120 kW

- 3 - Press SAVE. The Unit Controller is now set up to operate electric heat.

M4 Unit Controller

Use the following menu in the mobile app to enable electric heat.

RTU MENU > SETUP > INSTALL

Select configuration I.D. 2 and change (9) Field Electric Heat to Y (Installed).

Heating Operation

Cooling Units:

Single Stage (15 & 30 KW)

A W1 thermostat demand will energize the first stage of electric heat.

Two Stage (45, 60, 90 & 120 KW)

A W1 thermostat demand will energize the first stage of electric heat. A W2 thermostat demand will energize the second stage of electric heat after a 30 second delay.

Heat Pump Units:

A W1 thermostat demand will energize both compressors in heating mode (reversing valves are not energized). A W2 thermostat demand will energize the first stage of electric heat in addition to compressors operating in heat pump mode. For 45 through 90KW electric heat, the second stage of electric heat will be energized after a 30-second delay.

Unit Start-Up (Heating Cycle)

Set room thermostat for proper heat or auto operation if switching subbase is used. Apply power to unit and position heat setpoint lever above room temperature. Refer to unit installation instructions for additional information on start-up operations and adjustments.

Electric Heat Replacement Fuses

See the following tables for the proper replacement fuse sizes using the electric heat model number.

TABLE 5

Electric Heat Model ¹	Fuses ²			
	Qty	Class	Amps	Volt
EHA150-30-2Y	6	RK5	50	250
EHA150-30-2G	6	RK5	25	600
EHA150-30-2J	6	RK5	20	600
EHA156-15-1Y	6	RK5	60	250
EHA156-15-1G	3	RK5	50	600
EHA156-15-1J	3	RK5	40	600
EHA156-22.5-1Y	3	RK5	50	250
	3	RK5	25	250
EHA156-22.5-1G	3	RK5	25	600
	3	RK5	15	600
EHA156-22.5-1J	3	RK5	20	600
	3	RK5	10	600
EHA156-30-1Y	6	RK5	50	250
EHA156-30-1G	6	RK5	25	600
EHA156-30-1J	6	RK5	20	600

¹ Refer to Electric Heat Assembly nameplate

² Use Time Delay Type

TABLE 6				
Electric Heat Model¹	Fuses²			
	Qty	Class	Amps	Volt
EHA240-7.5-2Y	3	RK5	50	250
EHA240-7.5-2G	3	RK5	25	600
EHA240-7.5-2J	3	RK5	20	600
EHA360-15-2Y	6	RK5	60	250
EHA360-15-2G	3	RK5	50	600
EHA360-15-2J	3	RK5	40	600
EHA360-22.5-2Y	3	RK5	50	250
	3	RK5	25	250
EHA360-22.5-2G	3	RK5	25	600
	3	RK5	15	600
EHA360-22.5-2J	3	RK5	20	600
	3	RK5	10	600
EHA360-45-2Y	3	RK5	50	250
	6	RK5	60	250
EHA360-45-2G	3	RK5	25	600
	3	RK5	50	600
EHA360-45-2J	3	RK5	20	600
	3	RK5	40	600

¹ Refer to Electric Heat Assembly nameplate

² Use Time Delay Type