

INSTALLATION INSTRUCTIONS FOR WIRELESS ANTENNA (22A67) FOR USE WITH LENNOX® CORE UNIT CONTROLLER (M4/W4)

⚠ CAUTION

Electrostatic discharge can affect electronic components. Take precautions during unit installation and service to protect the unit's electronic controls. Precautions will help to avoid control exposure to electrostatic discharge by putting the unit, the control and the technician at the same electrostatic potential. Neutralize electrostatic charge by touching hand and all tools on an unpainted unit surface before performing any service procedure.

⚠ IMPORTANT

Improper installation, adjustment, alteration, service or maintenance can cause personal injury, loss of life, or damage to property.
Installation and service must be performed by a licensed professional installer (or equivalent) or a service agency.

⚠ WARNING



ELECTRICAL SHOCK HAZARD

STOP! Before you continue, make sure that power to the VFD has been off for at least 10 minutes. The capacitor in the VFD holds high voltage power for up to 10 minutes after power has been disconnected.

⚠ WARNING



ELECTRICAL SHOCK HAZARD

Can cause injury or death. Unit must be grounded in accordance with national and local codes.
Line voltage is present at all components when unit is not in operation on units with single-pole contactors. Disconnect all remote electrical power supplies before opening access panel. Unit may have multiple power supplies.

Shipping and Packing List

Package 1 of 1 contains:
1 - Wireless antenna

Overview

This instruction provides procedures on installation of the Core Unit Controller (M4/W4) wireless antenna on various roof top units. Refer to figures 3 - 7 for the applicable roof top unit (RTU) usage.

Existing Antenna Removal

1. Disconnect all power to the roof top unit (RTU).
2. Open compressor access panel.
3. Locate the wireless control board (W4) which is located on the CORE Unit Controller (M4).
4. Disconnect the SMA male connector from the female connector on the W4 control (see "Figure 1. Antenna Connection").

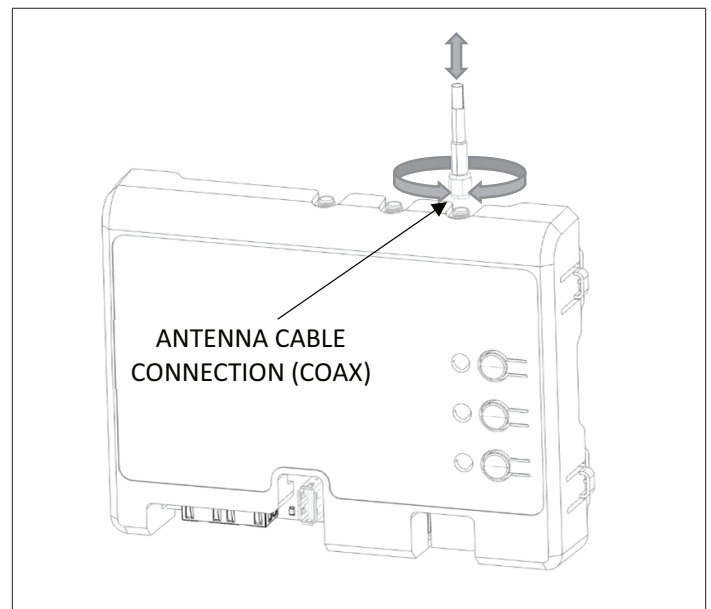

Figure 1. Antenna Connection

NOTE: SMA (sub-miniature version A) connector is a semi-precision coaxial RF connector. It is a minimal connector interface for coaxial cable with a screw-type coupling mechanism. The connector has a 50 Ω impedance.

5. Cut the wire ties that secure the existing cable and remove from the unit.

NOTE: Note the routing path. Refer to figures 3 - 7 for the applicable RTU routing.

6. Loosen the hex nut that secures the antenna to the mounting bracket and remove the antenna (see “Figure 2. Antenna Mounting Bracket”).

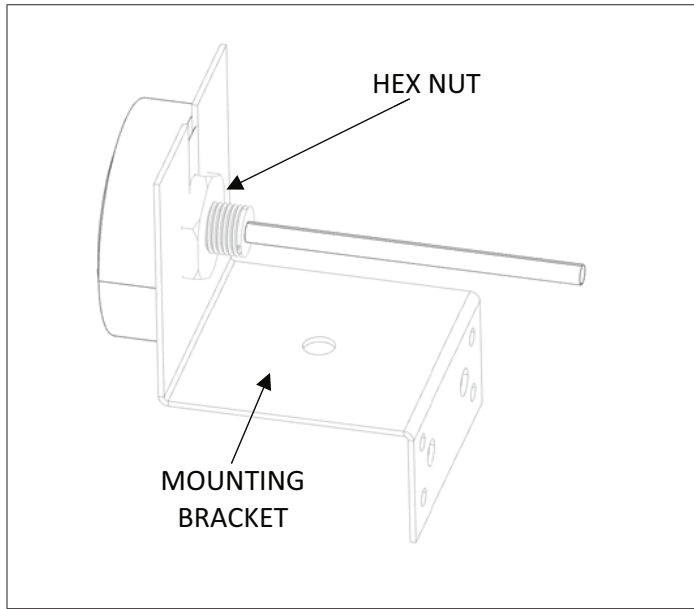

Figure 2. Antenna Mounting Bracket

New Antenna Installation

1. Secure the antenna to the mounting bracket in the same manner as the previous antenna was removed (see “Figure 2. Antenna Mounting Bracket”).
2. Route the cable along low voltage wires and separate from high voltage wires in the same manner as the previous cable was removed and routed. Refer to figures 3 - 7 for the applicable RTU routing.

NOTE: Avoid tight bends when routing the antenna cable. If there is excess cable length then bundle the cable together in the same manner as the previous cable was bundled.

3. Replace the cut wire ties with new ones (field-provided) and secure the cable and any loose harnesses.
4. Reconnect the antenna SMA male connector to the far right SMA female connector on the W4 control, then ensure a secure connection (see “Figure 1. Antenna Connection” on page 1)

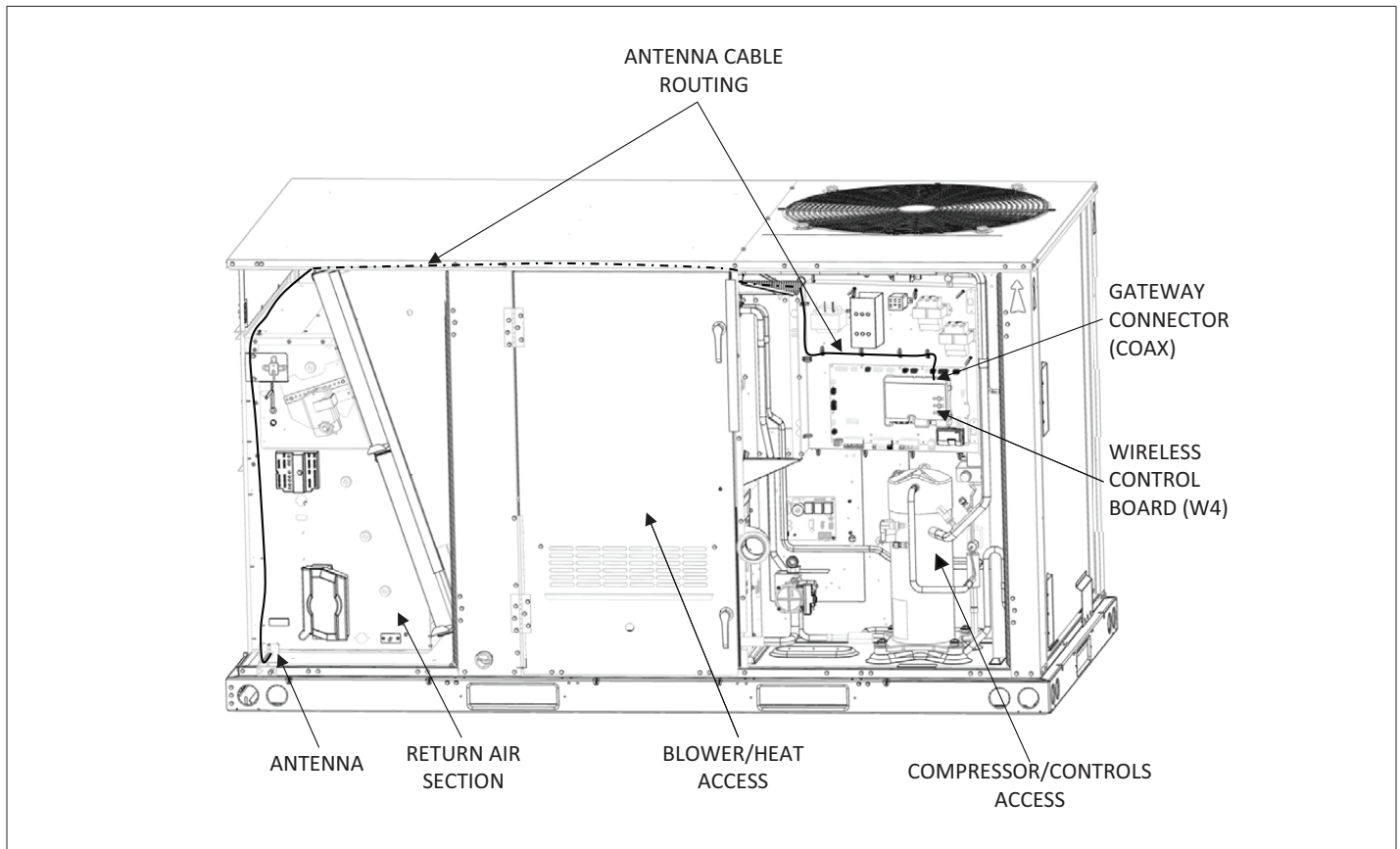

Figure 3. Antenna Mounting Location and Cable Routing - LCM/LGM036-074

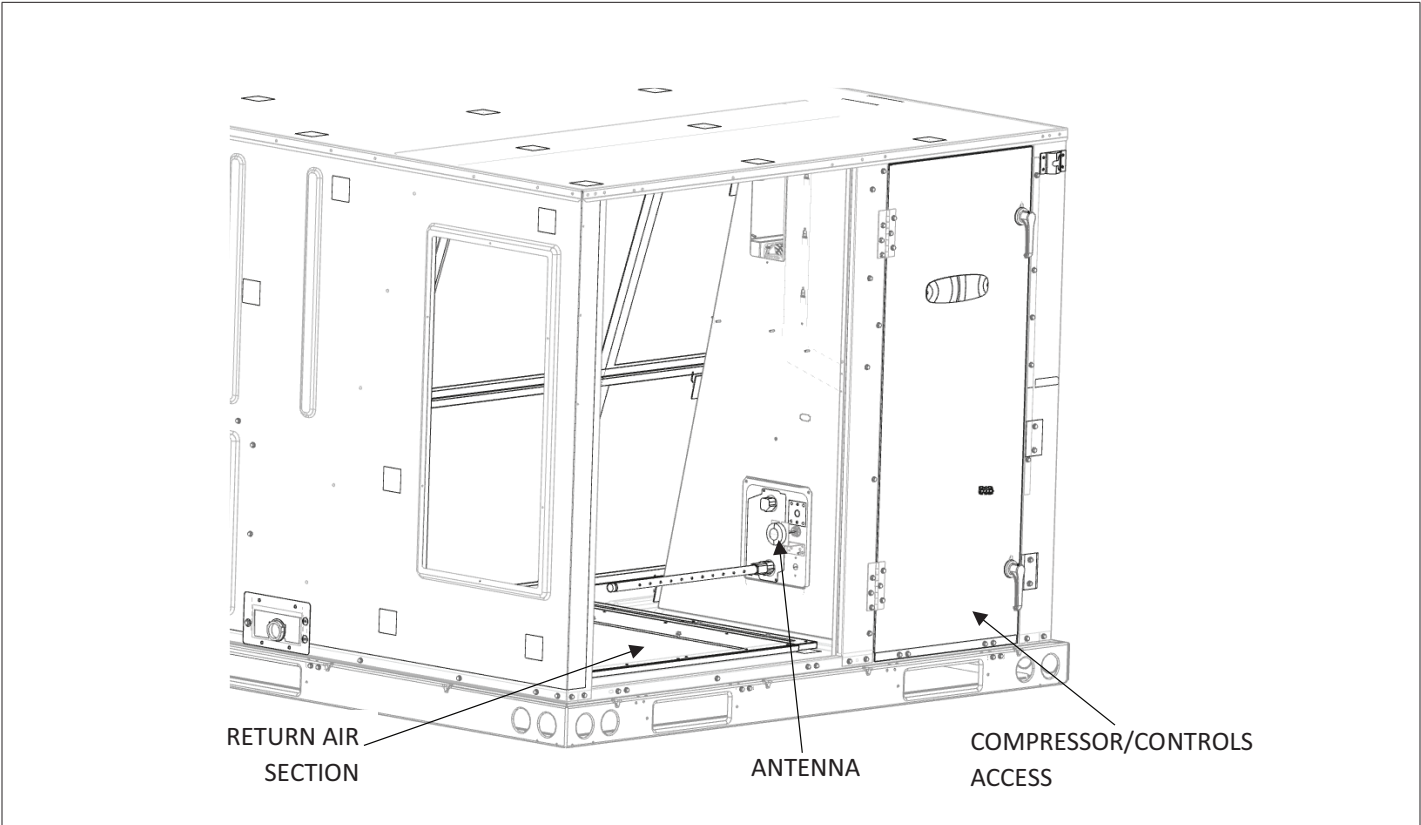

Figure 4. Antenna Mounting Location and Cable Routing - LCM/LGM092-150

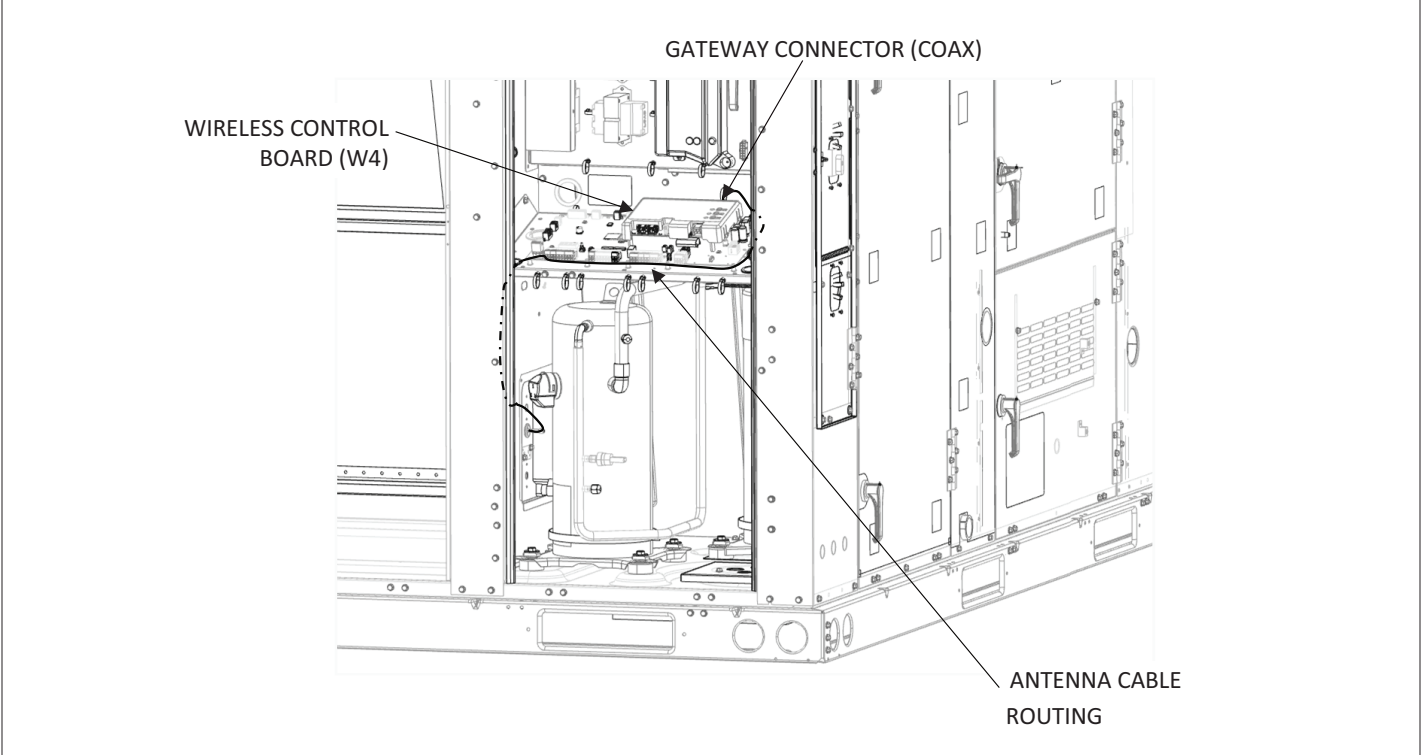

Figure 5. Antenna Mounting Location and Cable Routing - LCM/LGM092-150

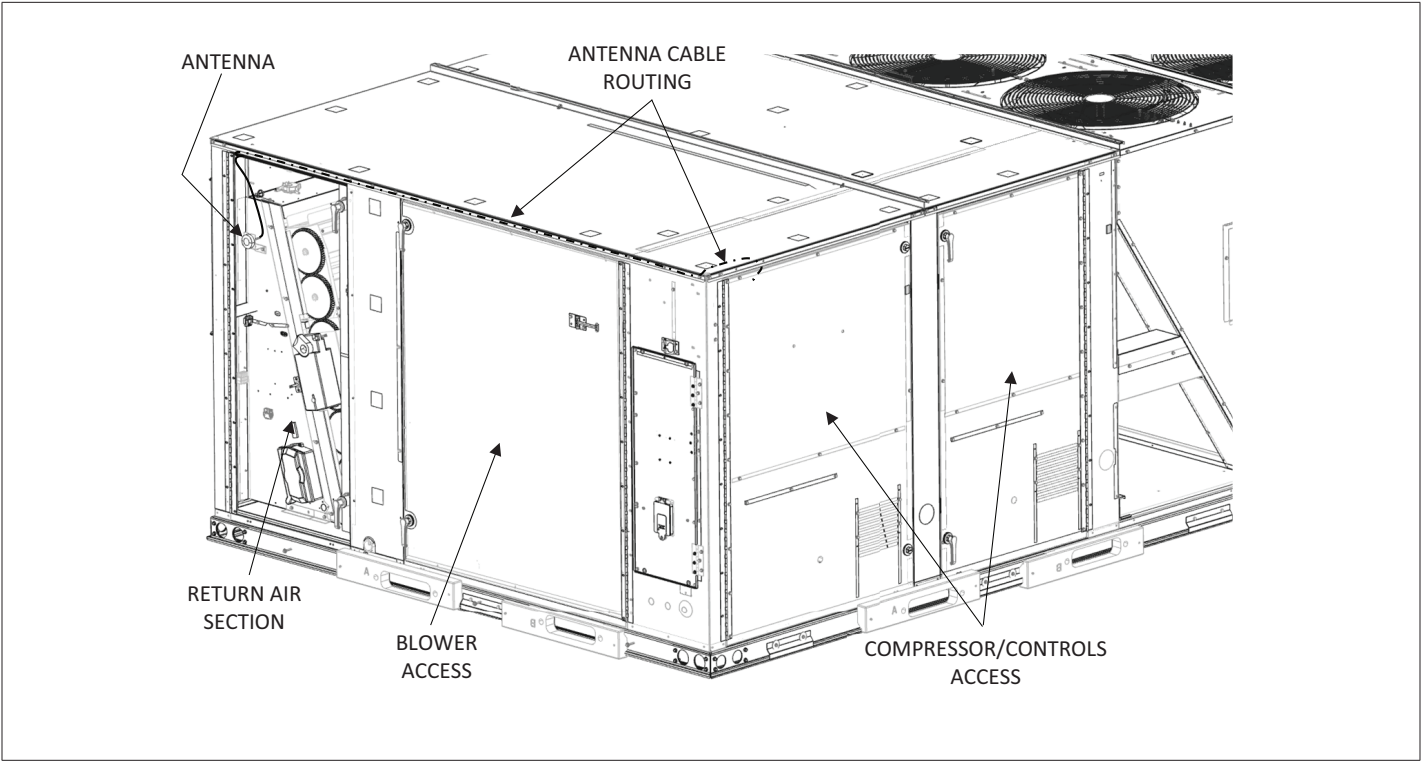

Figure 6. Antenna Mounting Location and Cable Routing - LCM/LGM156-300

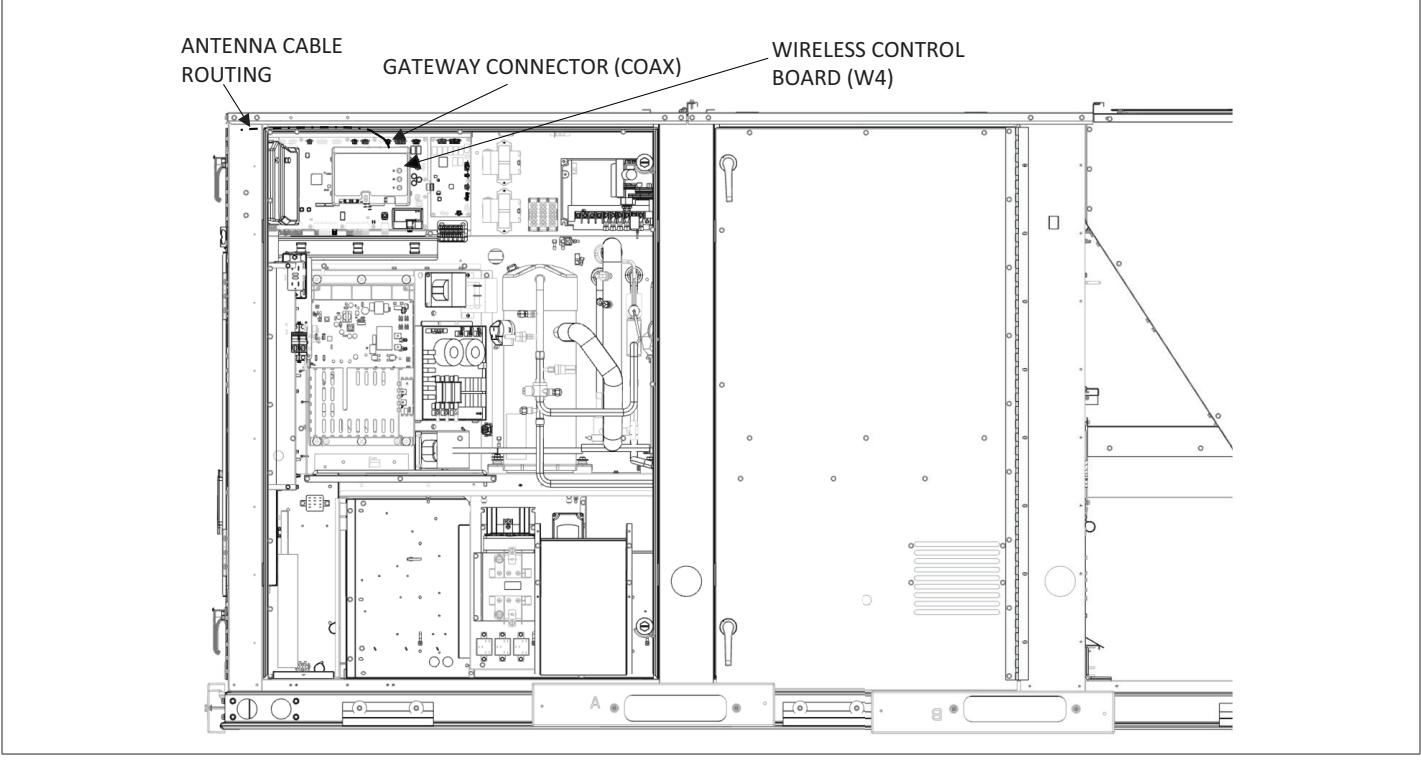

Figure 7. Antenna Mounting Location and Cable Routing - LCM/LGM156-300