



**MMDB**

Mini-Split

Medium Static Concealed Ducted Indoor Units - R-410A - 60 Hz

**RESIDENTIAL / COMMERCIAL  
PRODUCT SPECIFICATIONS**

Bulletin No. 211040  
April 2024  
Supersedes all previous versions



MMDB Medium Static Concealed Ducted Indoor Unit with Furnished Wired Remote Controller

**Nominal Capacity - 0.75 to 4 Tons**

**MODEL NUMBER IDENTIFICATION**

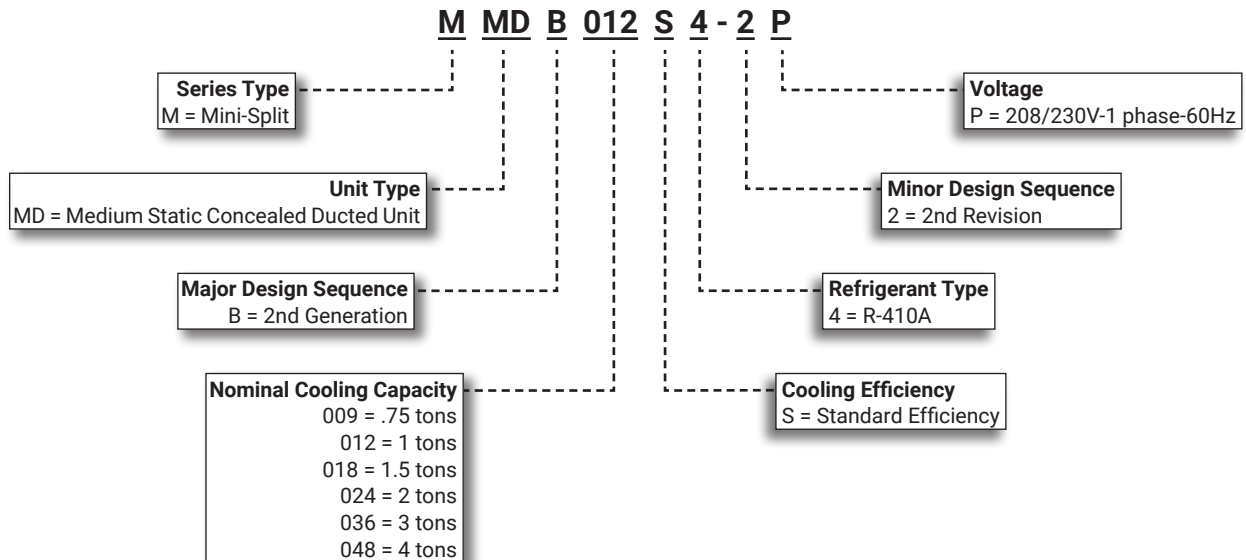

## CONTENTS

Approvals And Warranty . . . . .	2
Blower Data . . . . .	12
Dimensions . . . . .	18
Features . . . . .	2
Installation Clearances . . . . .	19
Optional Accessories - Order Separately . . . . .	11
Remote Controller - Furnished . . . . .	3
Remote Controllers - Optional . . . . .	5
Sound Levels - Test Conditions . . . . .	11
Specifications . . . . .	10

## APPROVALS AND WARRANTY

### APPROVALS

- Indoor units and components UL and CEC bonded for grounding to meet safety standards for servicing

### WARRANTY

- All covered components
  - Limited five years in residential applications
  - Limited one year in non-residential applications
- Accessories and controls - Limited one year

**NOTE** - Refer to Lennox Basic Limited Warranty at [www.Lennox.com](http://www.Lennox.com) for additional details.

## FEATURES

- Slim, compact design for limited space requirements. Installs out of sight between the drop ceiling and ceiling slab with ducted distribution to the indoor space
- **Pre-Heat Function** - Delays the operation of the fan until the indoor coil has reached a pre-determined temperature which prevents the discharge of cold air while the system is operating in the "heating" mode
- **LED Readout Panel** - Mounted in the unit control box unit. LEDs display unit operation status, and codes for maintenance and servicing
- **Auto Restart** - Automatically restores the previous function setting if power is interrupted
- **Cooling Override** - Button on the indoor unit allows a temporary 30 minute override of the system for forced "AUTO" or "COOLING" operation
- **Built-In Condensate Pump** - 27-1/2 inch lift
- **Duct Connections** - Return air connections can be made horizontally or from the bottom of the unit with interchangeable panel
- **Flare Connections** - Equipped with liquid and gas flare fittings for quick and secure piping
- **Three Speed Fan** - Fan functions at three speeds: low, medium and high
- **Air Filter** - Cleanable air filter is furnished as standard
- **Wired Remote Controller** - Furnished as standard, see Page 3

### AUTO CHANGEOVER OPERATION

- If the indoor unit is set to "AUTO" mode the unit will operate in cooling, heating or fan mode based on temperature setting
- Fan runs in auto mode

### OPTIONAL ACCESSORIES

#### Condensate Pumps

- Quietly and efficiently removes condensate
- See Optional Accessories Table for available pumps

#### A/C Easy Tee® Condensate Cleanout

- Condensate drain service port
- Flexible and easy to use with nitrogen, water or shop vac
- Screw cap on top allows easy access to condensate drain line

#### Wired Programmable Controller

- See Page 5

#### Wireless Remote Controller

- See

## REMOTE CONTROLLER - FURNISHED

### WIRED REMOTE CONTROLLER (M0STAT120L-1)



#### FEATURES

- Built-In Memory - Maintains clock, fan speed and mode of operation settings following power outages
- Dimensions (H x W x D) - 4-3/4 x 4-3/4 x 7/8 in.
- Additional hardware is furnished for installation
- 3-1/2 in. back-lit LCD display screen
- Wiring - Controller uses 5-wire shielded 20 ft. cable (furnished) for easy low voltage connection to the indoor unit
- Maximum cable length is 59 ft.

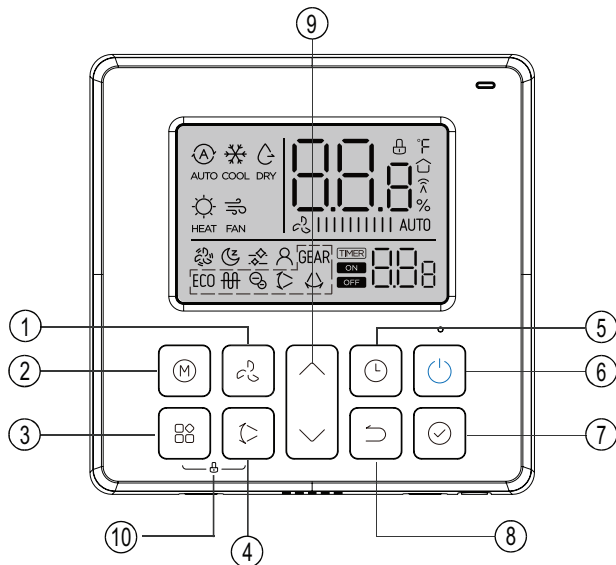

1. Turbo
2. Sleep
3. Active Clean
4. Follow Me

#### 4 SWING Button

- Used to stop or start louver auto swing feature (certain models)
- Louvers oscillate up and down automatically. Press and hold the Swing button again to disable.
- Pressing the Swing button multiple times will set the louvers at five different fixed airflow angles.
- Press and hold Swing button for 2 seconds to activate left/right louver operation. Louvers swing left and right automatically.

#### 5 TIMER Button

- TIMER ON (initiates an auto-on time sequence)
- TIMER OFF (initiates an auto-off time sequence) can be used separately or together
- Each press of the button increases the time in 30 minute increments up to 10 hours
- Above 10 hours each press of the button will increase the auto-timed setting by 60 minutes up to 24 hours

#### 6 POWER Button

- Turns system on and off

#### 7 CONFIRM Button

- Confirms selected function

**NOTE** - Press and hold and **Arrow Up** Button and the **Arrow Down** button together for 3 seconds to alternate the temperature display between the °F and °C scale.

#### 8 BACK Button

- Returns to the previous step

#### 9 UP/DOWN Buttons

- Increase or decrease the indoor temperature in two degree increments (maximum 86°F, minimum 60°F).

**NOTE** - Temperature cannot be adjusted in FAN mode.

#### 10 LOCK

- Press the **Function** and **Swing** buttons simultaneously to lock or unlock the Controller to prevent tampering with settings

### OPTIONAL ACCESSORIES

#### Extension Cable for Wired Remote Controller

- 20 ft. cable for easy low voltage connection to the indoor unit
- Extends cable to maximum 65 ft. length

#### 1 FAN SPEED Button

- Selects fan speed. Each button press cycles through the following settings on display

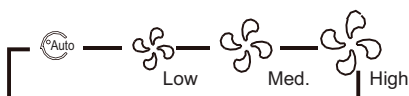

#### 2 MODE Button

- Select system operation modes. Push button to cycle through each setting

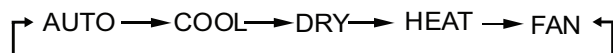

#### 3 FUNCTION Button

- Scrolls through unit operations in this order:

# REMOTE CONTROLLER - FURNISHED

## WIRED REMOTE CONTROLLER INDICATORS (M0STAT120L-1)

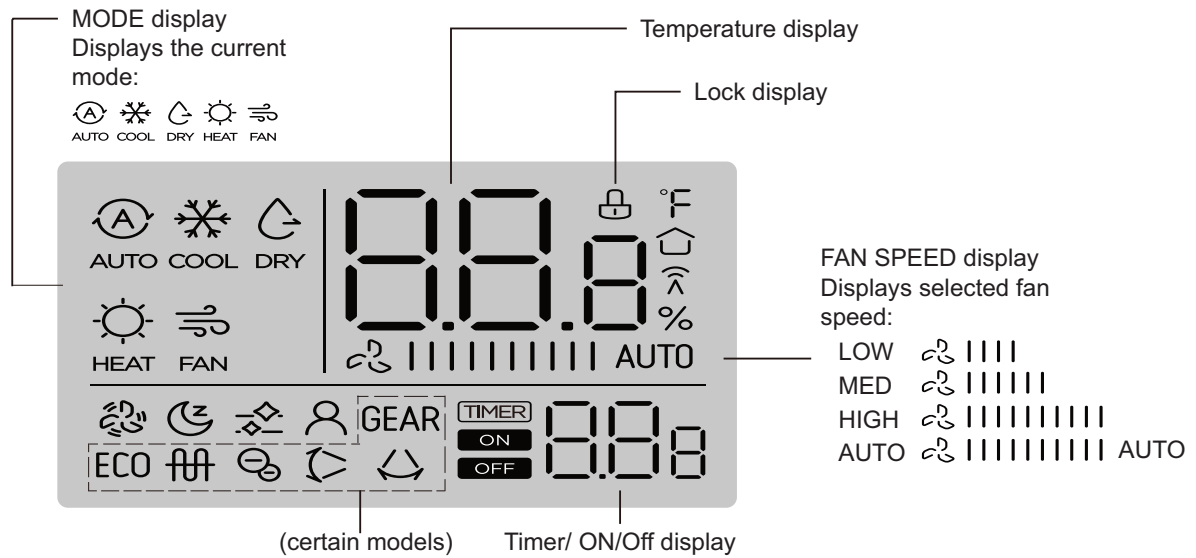

°F / °C display	🌀 Turbo feature display	GEAR GEAR feature display (certain models)
🏠 Room temperature display	🌀 Active clean display	ECO ECO feature display (on certain models)
👤 Follow me feature display	🌙 SLEEP feature display	🌀 Electric heating display (certain models)
🌀 Not used	🔄 UP and down swing (certain models)	🔄 Left and right swing (certain models)

**NOTE:**  
 All icons are shown for display purposes only.  
 During actual unit operation, only active icons are displayed.

## REMOTE CONTROLLERS - OPTIONAL

### WIRED PROGRAMMABLE CONTROLLER (M0STAT120N-1)



#### FEATURES

- Wired programmable local controller for mini-split indoor units with convenient timed schedules for daily operation
- Weekly timers (2), all days of the week timer, up to 8 scheduled events per day
- Schedule start time, mode, setpoint, and fan speed
- Compatible with all indoor units
- Copy/paste function for easy duplication of events to other days
- Built-in system diagnostics
- 3-1/2 in. back-lit LCD display screen
- Controller uses 4-wire shielded 20 ft. cable (furnished) for easy low voltage connection to the indoor unit
- Adaptor cables are furnished for various indoor unit connections

**NOTE** - Cable for longer lengths must be ordered separately.

**NOTE** - Maximum cable length is 164 ft..

- Hardware for mounting furnished
- Mounts to standard electrical junction box (not furnished)
- Lithium battery furnished: CR2032
- Power Supply: 12 VDC
- Dimensions (H x W x D): 4-3/4 x 4-3/4 x 7/8 in.
- Audible tone when a button is pressed (can be disabled)
- Lock function disables buttons to prevent tampering

#### DISPLAY

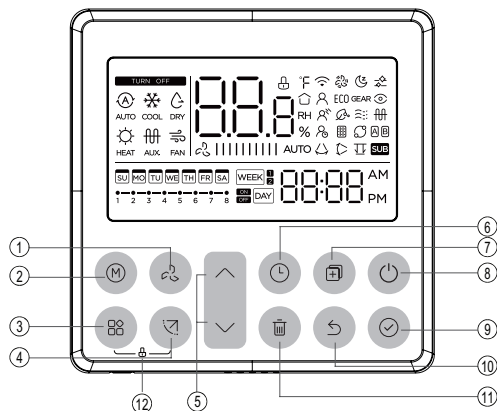

#### BUTTONS AND FUNCTIONS

- FAN SPEED Button**
  - Scroll through fan speeds (Auto - Low - Med - High)
- MODE Button**
  - Use + and – buttons to scroll through available operation modes (Auto / Cool / Dry / Heat / Fan)
- FUNCTION Button**
  - Scrolls through unit operations in this order:
    1. Turbo
    2. Sleep
    3. Follow Me
- SWING Button**
  - Used to stop or start louver auto swing feature (certain models)
  - Louvers oscillate up and down automatically. Press and hold the Swing button again to disable.
  - Pressing the Swing button multiple times will set the louvers at five different fixed airflow angles.
  - Press and hold Swing button for 2 seconds to activate left/right louver operation. Louvers swing left and right automatically.
- UP/DOWN Buttons**
  - Increase or decrease the indoor temperature in one degree increments (maximum 86°F, minimum 60°F).
  - NOTE** - Temperature cannot be adjusted in FAN mode.
- TIMER Button**
  - Sets unit for daily or weekly on/off operation
- COPY Button**
  - Copy schedules from one day to another
- POWER Button**
  - Turn system on and off
- CONFIRM Button**
  - Confirms each step when managing schedules
  - NOTE** - Press and hold and **Confirm** Button and the **Arrow Down** button together for 3 seconds to alternate the temperature display between the °F and °C scale.
- BACK Button**
  - Returns to the previous step
- DAY OFF/DELAY BUTTON**
  - Disable specific days/schedules of the week
  - Delete a specific event
- LOCK**
  - Press the **Function** and **Swing** buttons simultaneously to lock the Controller to prevent tampering with settings

#### OPTIONAL ACCESSORIES

- Extension Cable for Wired Programmable Controller**
- 20 ft. cable for easy low voltage connection to the indoor unit
  - Extends cable to 40 ft. (12 m) length

# REMOTE CONTROLLERS - OPTIONAL

## WIRED PROGRAMMABLE REMOTE CONTROLLER INDICATORS (M0STAT120N-1)

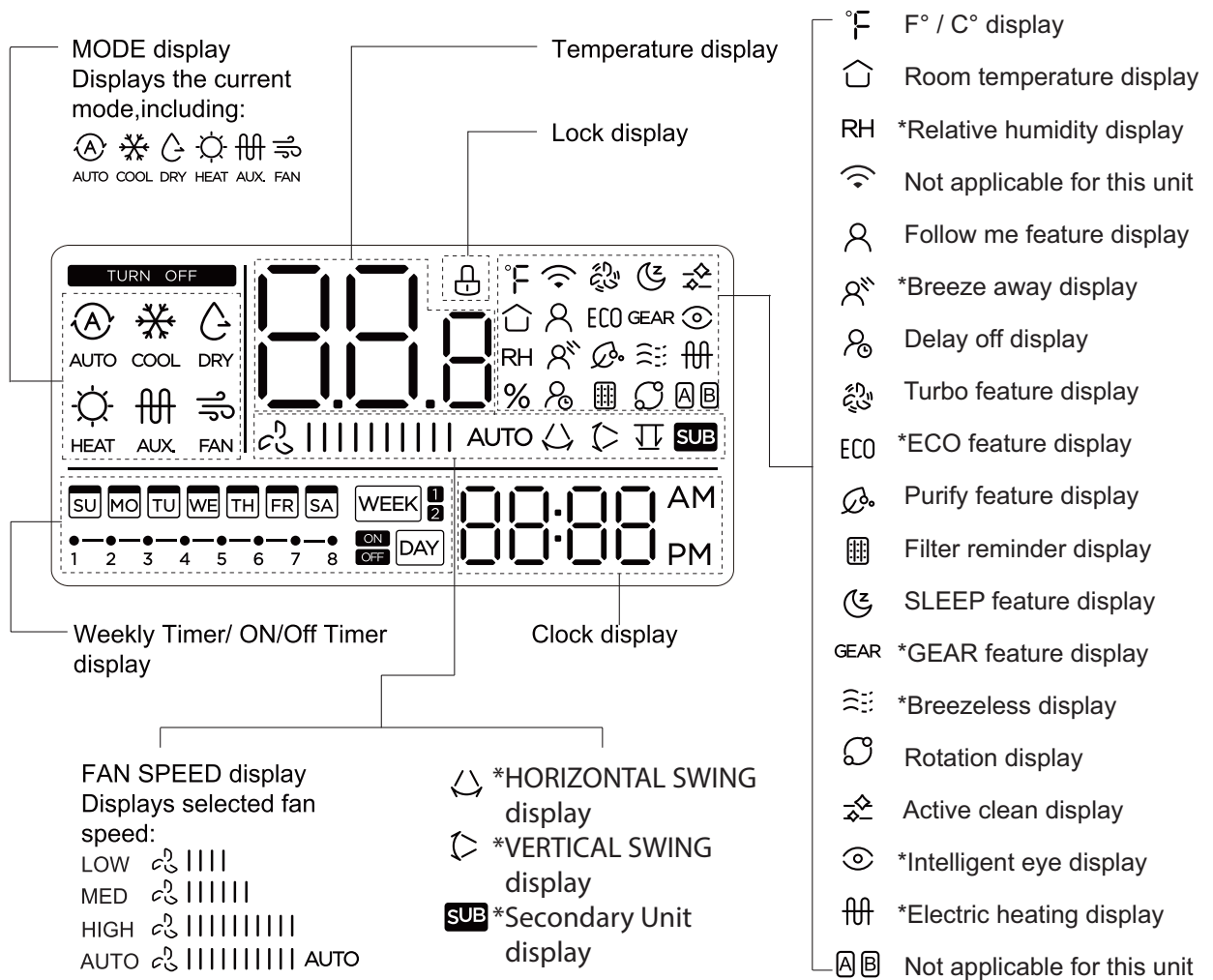

**NOTE:**

All icons are shown for display purposes only.

During actual unit operation, only active icons are displayed.

*\*Certain Models*

## REMOTE CONTROLLERS - OPTIONAL

### WIRELESS REMOTE CONTROLLER (RG10B-DCFC)

- Complete remote control of system
- Maximum operating range is 25 ft.
- Operates on two AAA 1.5V batteries (furnished)
- Wireless remote controller holder furnished
- Holder can be mounted on a wall for easy access
- Mounting screws furnished

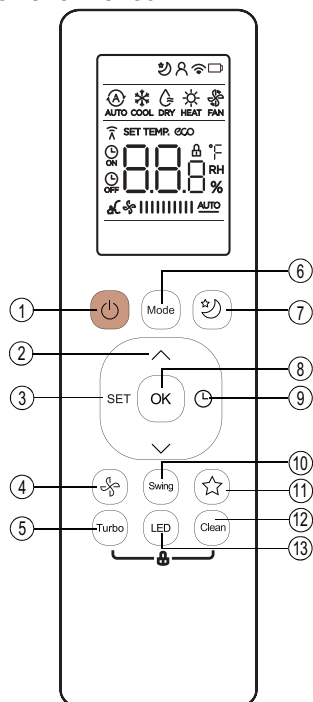

#### 1 ON/OFF Button

- Turns system on and off

#### 2 UP/DOWN Buttons ^ v

- Increase or decrease the indoor temperature in one degree increments (maximum 86°F, minimum 62°F)

**NOTE** - Temperature cannot be adjusted in FAN mode.

**NOTE** - Press and hold and buttons together for 3 seconds to alternate the temperature display between the °C and °F scale.

#### 3 SET Button

- Scrolls through unit operations in this order:

1. Follow Me

**NOTE** - The selected symbol will flash on the display area. Press the OK button to confirm.

#### 4 FAN Button

- Cycles fan speeds in the following order:

• AUTO → LOW → MED → HIGH

**NOTE** - Holding Fan button down for 2 seconds will activate **Silence** feature.

#### 5 TURBO Button

- Enables the unit to reach the preset temperature during cooling or heating operation in the shortest time

#### 6 MODE Button

- Select system operation modes
- Press button to cycle through each setting:
  - AUTO → COOL → DRY → HEAT → FAN

#### 7 SLEEP Button

##### Sleep

- Enables the system to automatically increase cooling or decrease heating (in 2°F increments) per hour for the first 2 hours, then maintain a steady temperature for 5 hours
- System keeps the final operation mode after 8 total hours of operation

#### 8 OK Button

- Confirms selected function

#### 9 TIMER Button

- Initiates an auto-on or auto-off time sequence
- Press TIMER button to initiate the ON time sequence
- Press Temp. up or down button for multiple times to set the desired time to turn on the unit
- Press TIMER button to initiate the OFF time sequence.

**NOTE** - Each press of the button increases or decreases the time (depending on function) in 30 minute increments up to 10 hours.

Above 10 hours each press of the button will increase or decrease the auto-timed setting by 60 minutes up to 24 hours.

To cancel, set timer to 0.0 or turn remote off and on.

#### 10 SWING Button

- Used to stop or start louver auto swing feature

#### 11 SHORTCUT Button

- Restore the current settings or resume the previous settings

#### 12 CLEAN Button

- Start/stop the Self-Clean function
- Unit cleans itself automatically

**NOTE** - Only available in COOL or DRY modes.

**NOTE** - Not for MCFA036-048 and MMDB036-048 models.

#### 13 LED Button

- Turns the LCD display backlight on the indoor unit on or off

**NOTE** - Press and hold the button for 5 seconds to display the actual room temperature. Press more than 5 seconds to revert back to display set temperature.

## REMOTE CONTROLLERS - OPTIONAL

### WIRELESS REMOTE CONTROLLER INDICATORS (RG10B-DCFC)

Information is displayed when the Wireless Remote Controller is powered on.

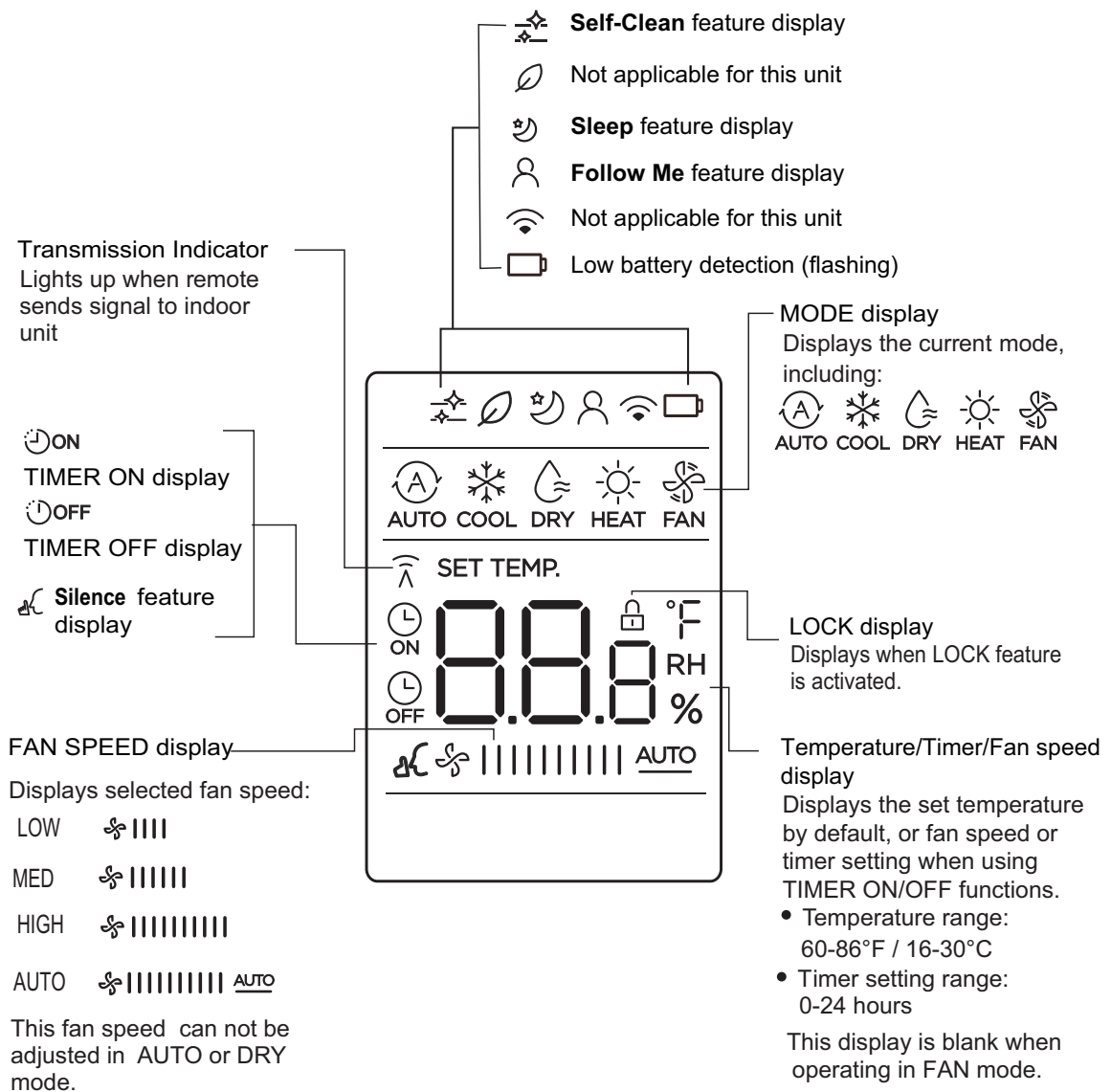

**Note:**

All icons are shown for display purposes only.  
During actual unit operation, only active icons are displayed.



## REMOTE CONTROLLERS - OPTIONAL

### WIRELESS REMOTE CONTROLLER OPERATION (RG10B-DCFC)

#### Auto Operation

1. Press the **MODE** button to select Auto.
2. Press the **UP/DOWN** button to set the desired temperature.
3. Press the **ON/OFF** button to start the system.

#### Cooling /Heating/Fan Operation

1. Press the **MODE** button to select **COOL**, **HEAT** or **FAN** mode.
2. Press the **UP/DOWN** buttons to set the desired temperature.
3. Press the **FAN** button to select the fan speed in four steps- Auto, Low, Med or High.
4. Press the **ON/OFF** button to start the system.

#### Dehumidifying (DRY) Operation

1. Press the **MODE** button to select **DRY** mode.
2. Press the **UP/DOWN** buttons to set the desired temperature.
3. Press the **ON/OFF** button to start the system.

**NOTE** - Fan speed selection is disabled.

#### Timer ON/OFF Operation

1. Press the **TIMER** button. The remote controller shows **TIMER ON** or **TIMER OFF** icon
2. Press the **TIMER** button again to set desired time. Each time the button is pressed the time increases by 30 minutes between 0 and 10 hours and then by 60 minutes between 10 and 24 hours.
3. After setting the **TIMER ON** or **TIMER OFF** there will be a one second delay before the remote controller transmits the signal to the unit. After approximately 2 seconds the set temperature will re-appear on the LCD display window.

#### Silence Operation

1. Press the **FAN** button for more than 2 seconds to activate or disable the Silence function

#### Lock Function

1. Press the **TURBO** and **HUMIDITY** buttons together two times in less than one second to lock the Controller to prevent tampering
2. Press the **TURBO** and **HUMIDITY** together buttons again for two seconds to unlock the Controller

#### Swing Function

1. Press the **Swing** button to activate parallel louver operation. Louvers oscillate up and down automatically. Press and hold the Swing button again to disable.

**NOTE** - Pressing the Swing button multiple times will set the louvers at five different fixed airflow angles.

2. Press **Swing** button for 2 seconds to activate upright louver operation. Louvers swing left and right automatically.

### SET BUTTON FUNCTIONS

#### Follow Me

- Allows remote temperature sensing of the room at the remote controller location

## SPECIFICATIONS

Model No.		MMDB009S4	MMDB012S4	MMDB018S4
Nominal Tons		0.75	1	1.5
Power Supply - 60 hz - 1 phase		208/230V	208/230V	208/230V
Rated load amps		1.27	1.37	1.3
Output (W)		55	55	160
Room Temperature Range (°F)	Cooling	60 - 90	60 - 90	60 - 90
	Heating	32 - 86	32 - 86	32 - 86
Air Volume - cfm (High/Medium/Low)		353 / 282 / 176	353 / 282 / 176	529 / 450 / 371
External Static Pressure (in. w.g)		0 - 0.16	0 - 0.16	0 - 0.40
Sound Data (dBA) - Low/Medium/High		27 / 28.5 / 33.5	31 / 34.5 / 38	35 / 37.5 / 40
Piping Connections - Liquid/Gas - o.d. - flare - in.		1/4 / 3/8	1/4 / 1/2	1/4 / 1/2
Drain connection o.d. - in.		1	1	1
Net/Shipping weights - lbs.		38 / 49	38 / 49	54 / 66

## SPECIFICATIONS

Model No.		MMDB024S4	MMDB036S4	MMDB048S4
Nominal Tons		2	3	4
Power Supply - 60 hz - 1 phase		208/230V	208/230V	208/230V
Rated load amps		1.7	2.45	2.50
Output (W)		160	300	560
Room Temperature Range (°F)	Cooling	60 - 90	60 - 90	60 - 90
	Heating	32 - 86	32 - 86	32 - 86
Air Volume - cfm (High/Medium/Low)		775 / 693 / 435	1082 / 912 / 703	1228 / 1031 / 715
External Static Pressure (in. w.g)		0 - 0.64	0 - 0.64	0 - 0.64
Sound Data (dBA) - Low/Medium/High		37 / 41 / 44	40.5 / 43.5 / 48	49 / 50 / 52
Piping Connections - Liquid/Gas - o.d. - flare - in.		3/8 / 5/8	3/8 / 5/8	3/8 / 5/8
Drain connection o.d. - in.		1	1	1
Net/Shipping weights - lbs.		87 / 103	106 / 122	120 / 142

## OPTIONAL ACCESSORIES - ORDER SEPARATELY

Description	Catalog No.	Size						
		009	012	018	024	036	048	
<b>INDOOR UNIT</b>								
<sup>1</sup> Diversitech Condensate Pumps with Reservoir	Mini-Split Pump - 4 US gallons per hour, 20 ft. lift - 230V	<b>Y7949</b>	•	•	•	•	•	•
	ClearVue Mini™ - 7.9 US gallons per hour, 35 ft. lift - 120-240V	<b>Y5170</b>	•	•	•	•	•	•
<sup>1</sup> Blue Diamond® Condensate Pumps with Reservoir	MicroBlue® - 1.3 US gallons per hour, 6 ft. lift - 110-230V	<b>14T74</b>	•	•	•	N/A		
	MaxiBlue® - 3.7 US gallons per hour, 16.5 ft. lift - 208/230V	<b>14T69</b>	N/A			•	•	N/A
	MegaBlue® - 13.2 US gallons per hour, 23 ft. lift - 208/230V	<b>14T71</b>	N/A					•
	MultiTank Kit	<b>14T75</b>	N/A			•	•	•
	Sensor Cable Extension - 16 ft.	<b>14T76</b>	•	•	•	•	•	•
Little Giant Condensate Pump Kit with Reservoir	Mini-Split Pump Kit - 2.5 US gallons per hour, 3 ft. lift - 100-240V (includes pump, reservoir, multi-size hose drain adaptor, 7 ft. detachable power cord, pump enclosure/cover, line set cover and mounting trim brackets)	<b>Y8794</b>	•	•	•	•	•	•
A/C Easy Tee® Condensate Cleanout		<b>Y7947</b>	•	•	•	•	•	•
<b>CONTROLS</b>								
Wired Programmable Controller	M0STAT120N-1	<b>24X03</b>	•	•	•	•	•	•
Extension Cable for Wired Programmable Controller - 20 ft.	M0CTRL64Q-1	<b>Y8738</b>	•	•	•	•	•	•
Wireless Remote Controller	RG10B-DCFC	<b>22U50</b>	•	•	•	•	•	•
Indoor/Outdoor Wiring Cable - 14 Gauge, 4 conductor wire, THHN, 250 ft.		<b>Y2067</b>	•	•	•	•	•	•

<sup>1</sup> Y7949 and 14T74 condensate pumps can be installed inside the indoor units. All other pumps must be installed external to the indoor unit.

## SOUND LEVELS - TEST CONDITIONS

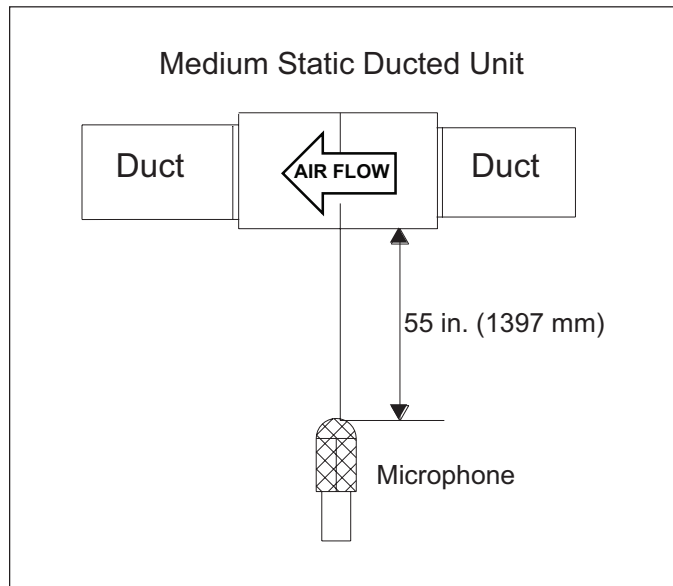

# BLOWER DATA

## MMDB009S4

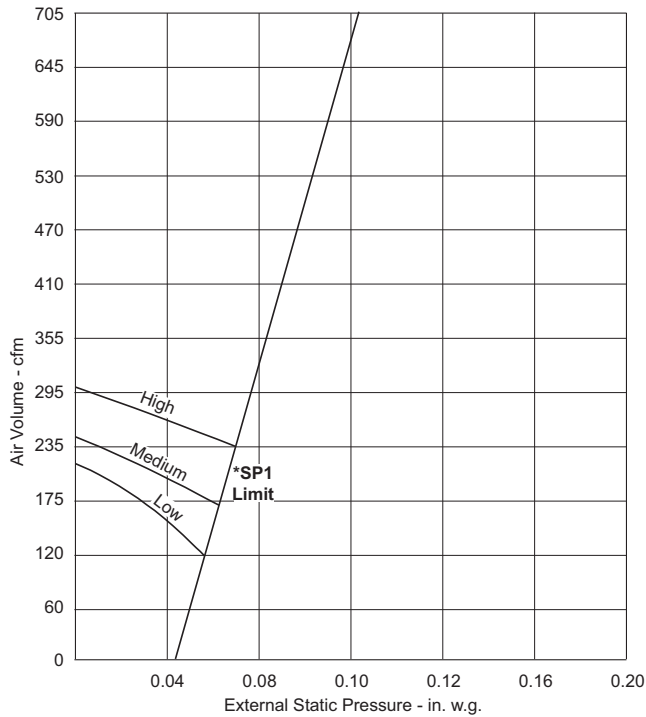

\*SP1 Limit airflow rate setting on the controller.

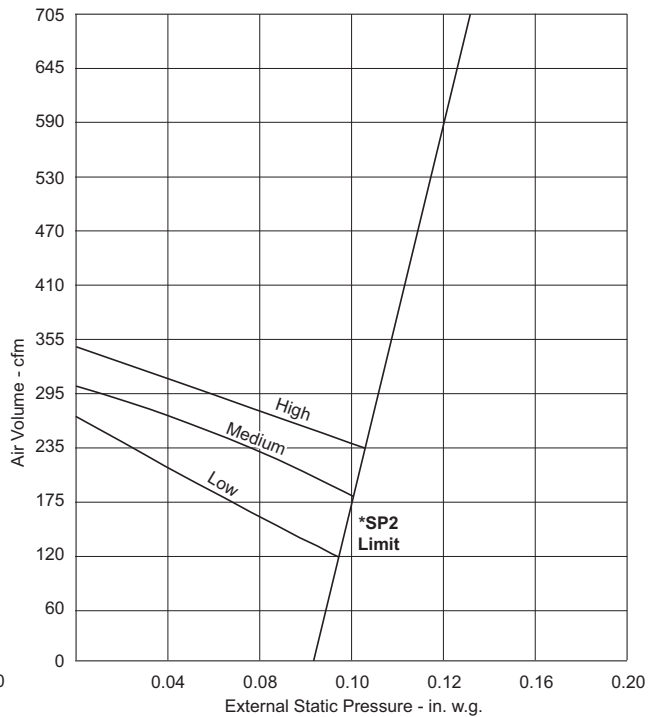

\*SP2 Limit airflow rate setting on the controller.

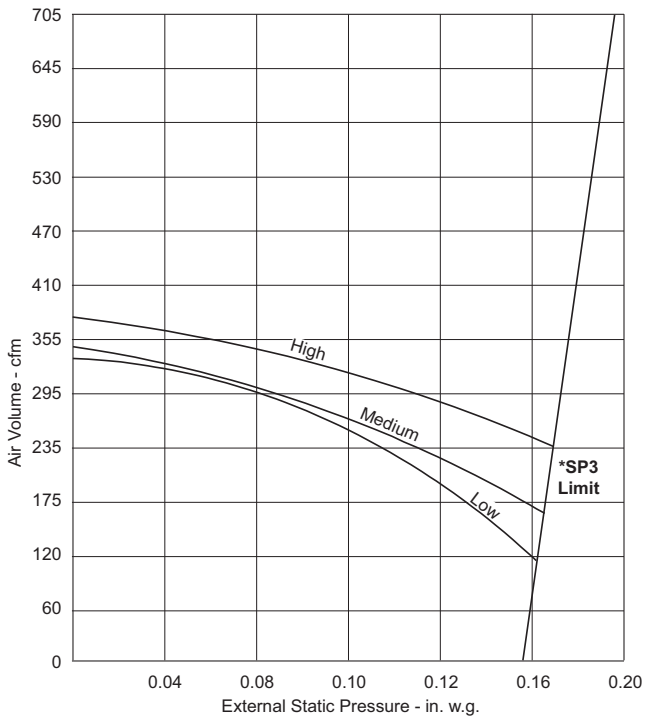

\*SP3 Limit airflow rate setting on the controller.

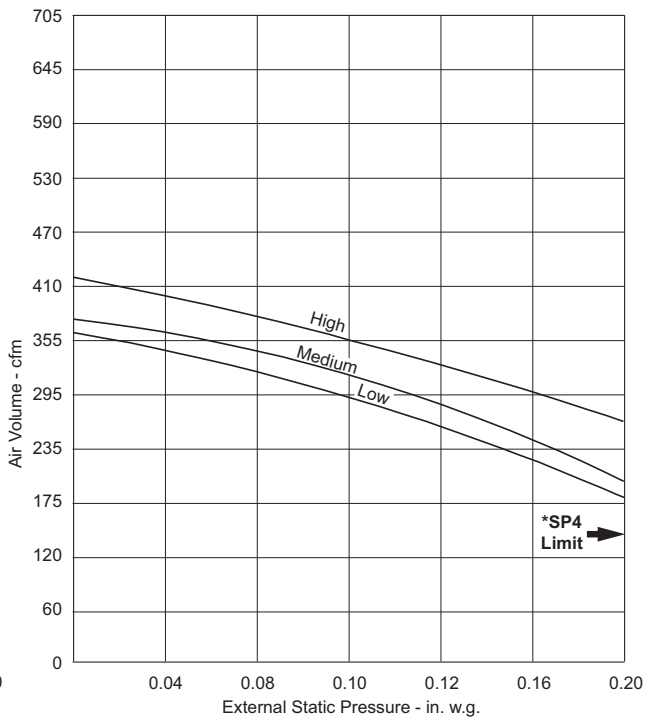

\*SP4 Limit airflow rate setting on the controller.

# BLOWER DATA

## MMDB012S4

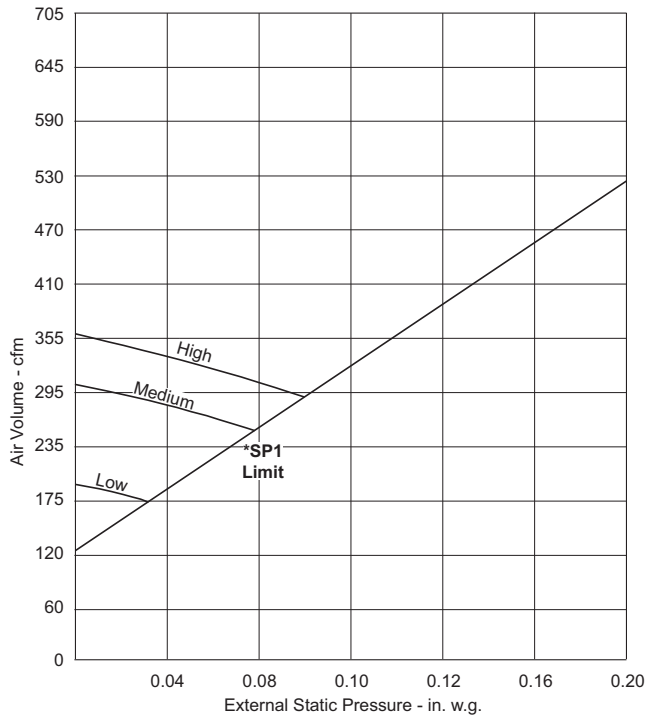

\*SP1 Limit airflow rate setting on the controller.

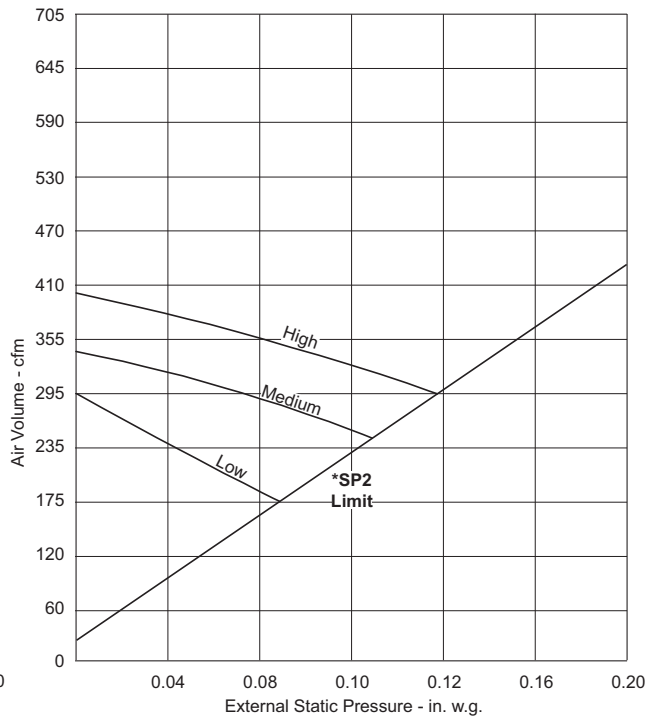

\*SP2 Limit airflow rate setting on the controller.

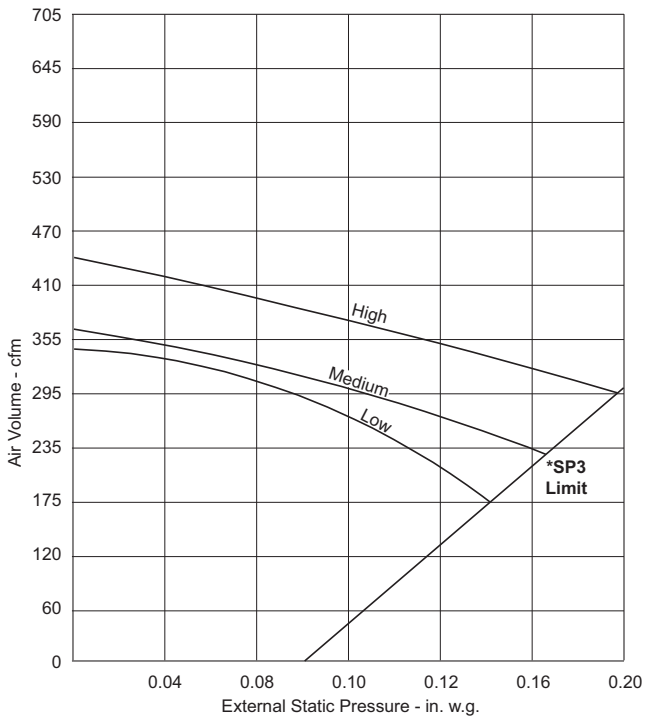

\*SP3 Limit airflow rate setting on the controller.

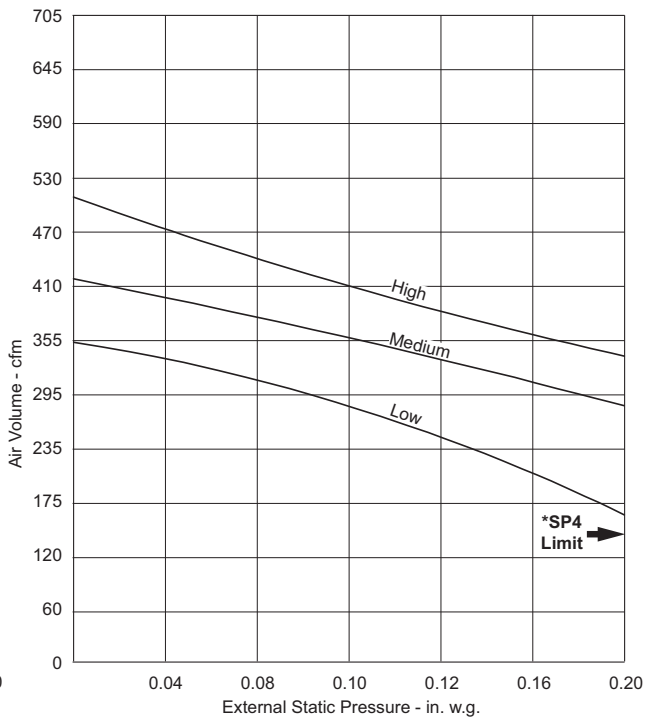

\*SP4 Limit airflow rate setting on the controller.

# BLOWER DATA

## MMDB018S4

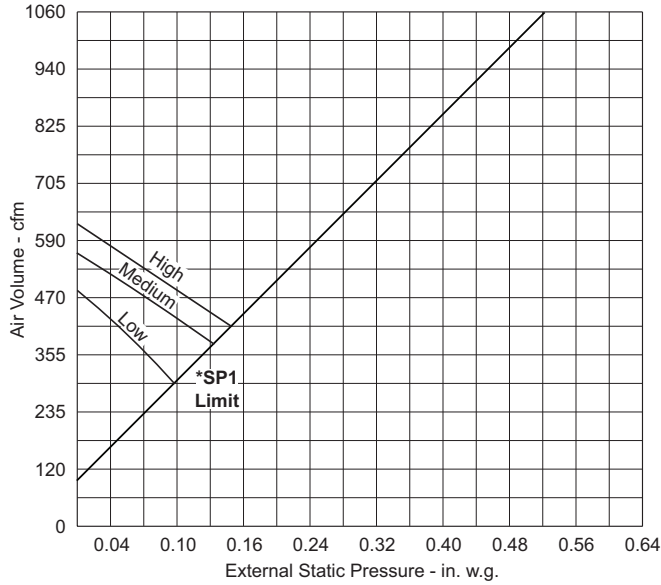

\*SP1 Limit airflow rate setting on the controller.

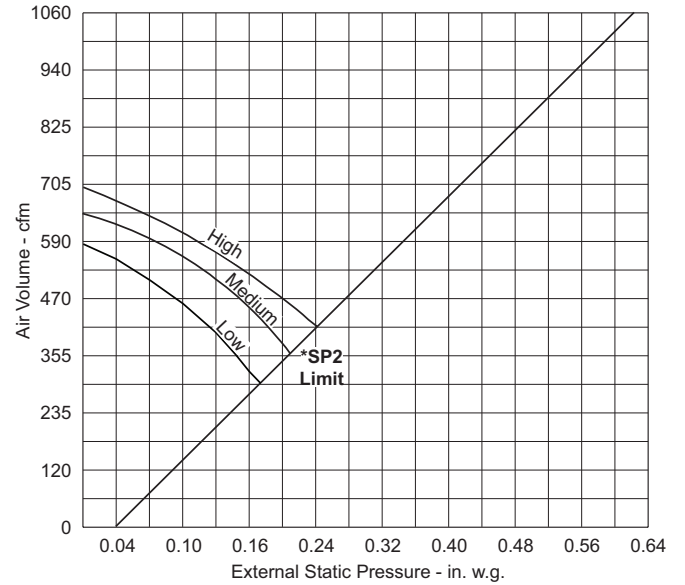

\*SP2 Limit airflow rate setting on the controller.

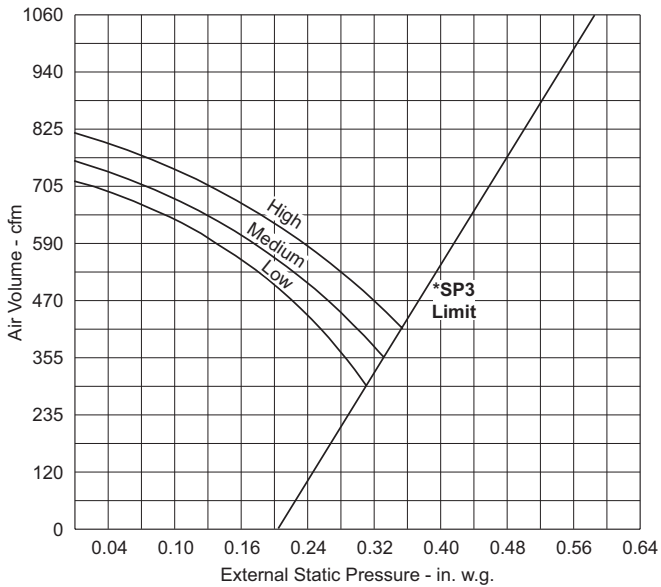

\*SP3 Limit airflow rate setting on the controller.

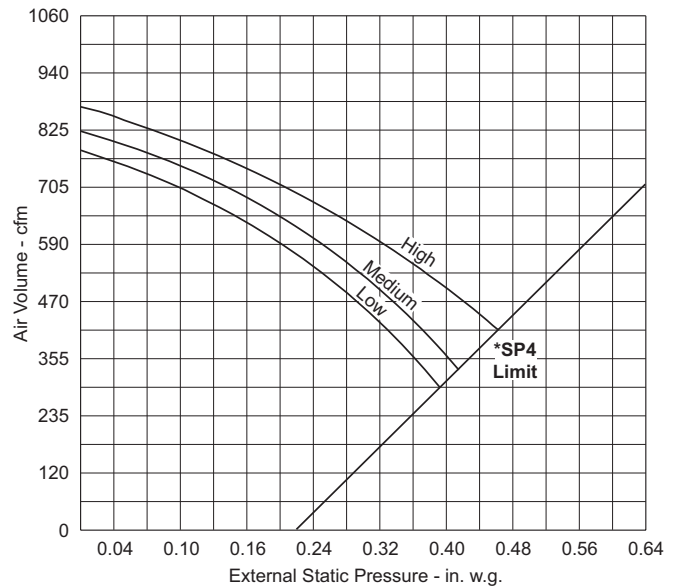

\*SP4 Limit airflow rate setting on the controller.

# BLOWER DATA

## MMDB024S4

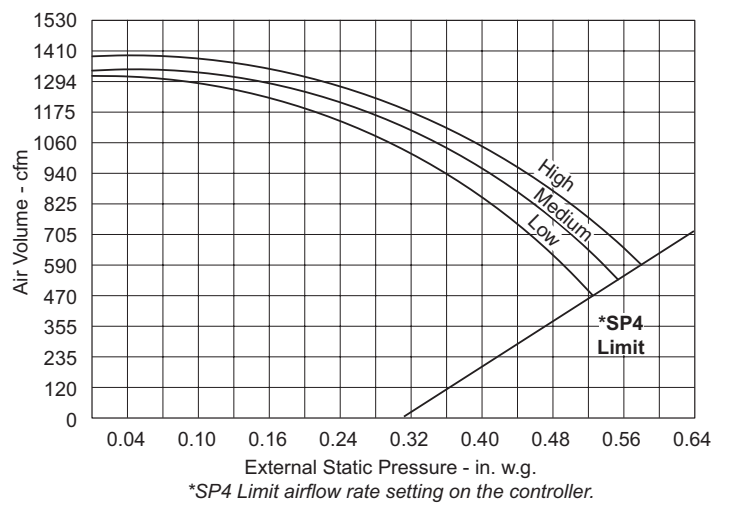
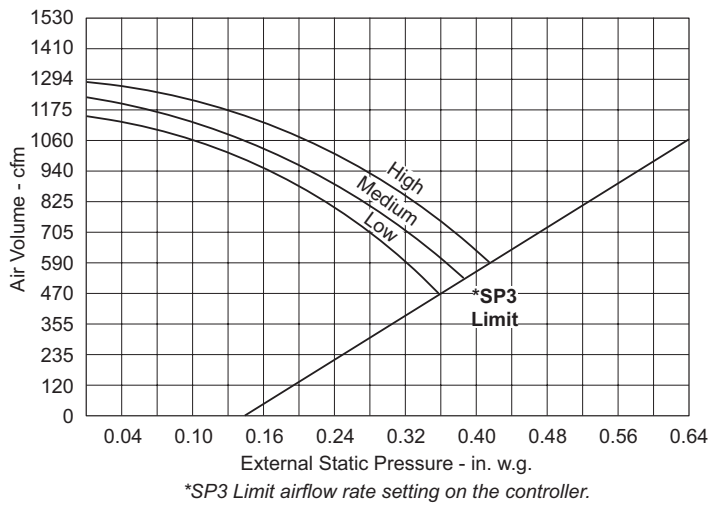
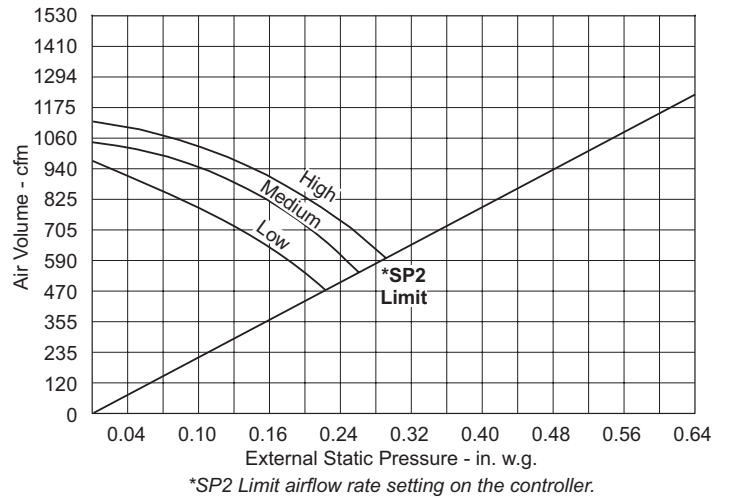
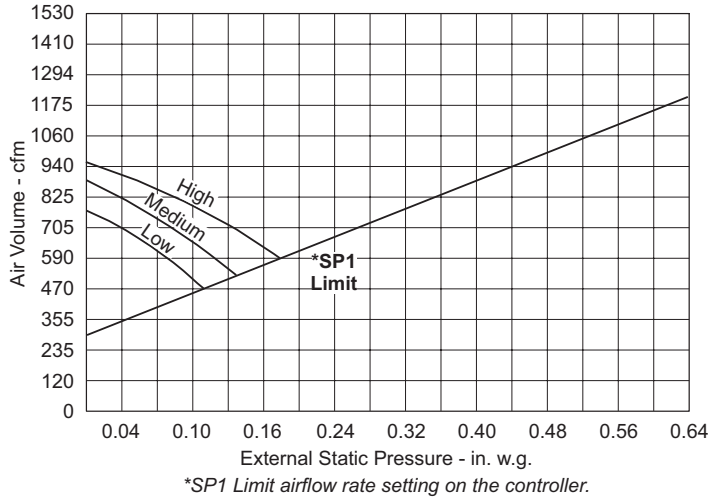

# BLOWER DATA

## MMDB036S4

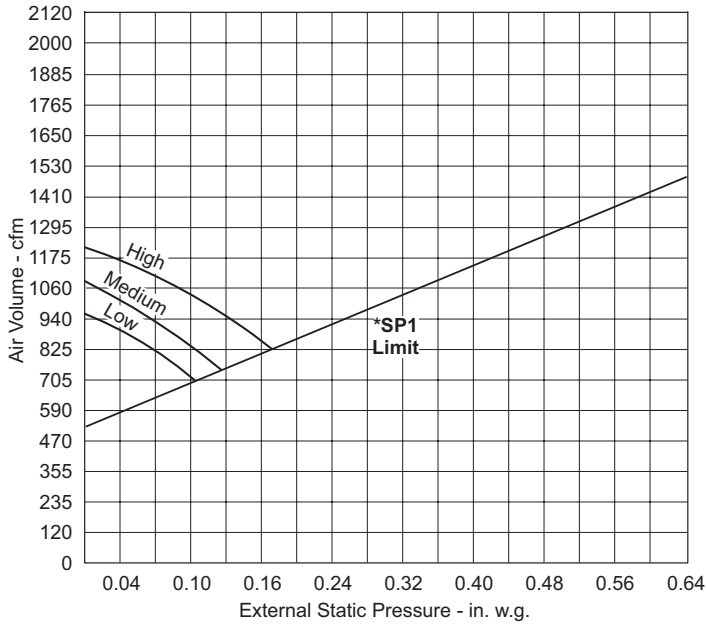

\*SP1 Limit airflow rate setting on the controller.

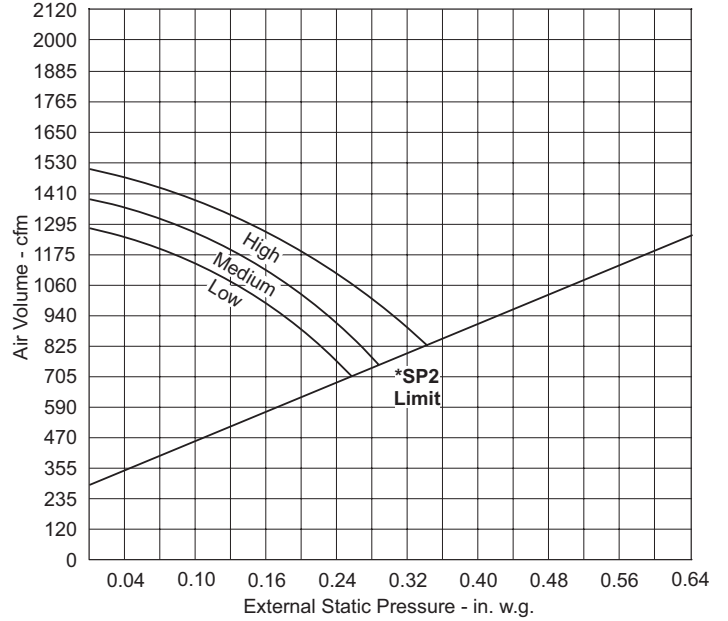

\*SP2 Limit airflow rate setting on the controller.

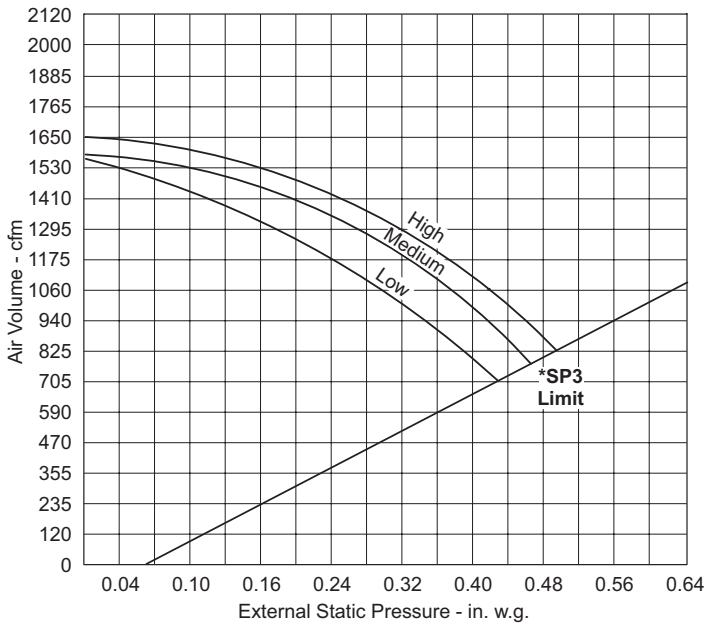

\*SP3 Limit airflow rate setting on the controller.

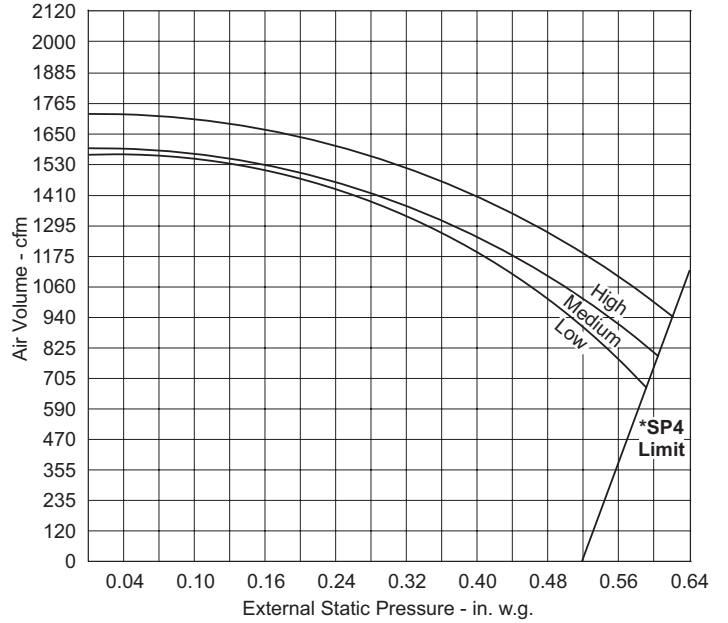

\*SP4 Limit airflow rate setting on the controller.



# BLOWER DATA

## MMDB048S4

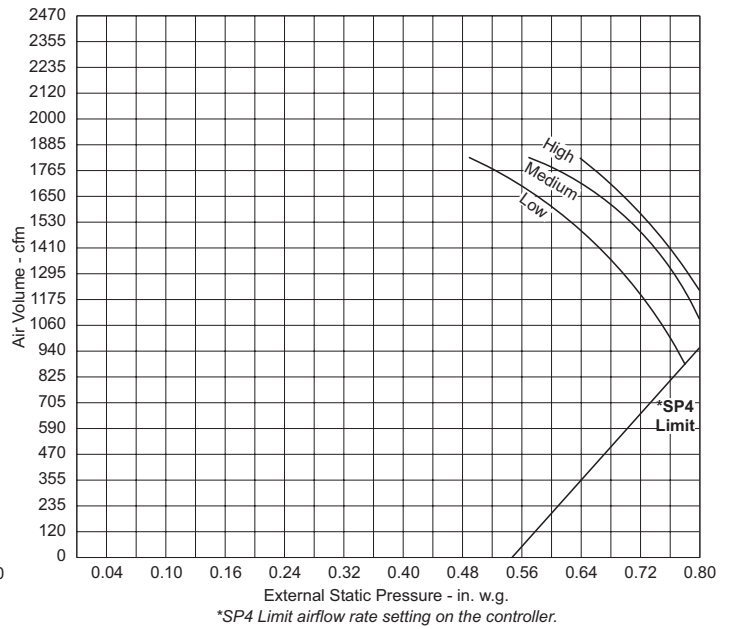
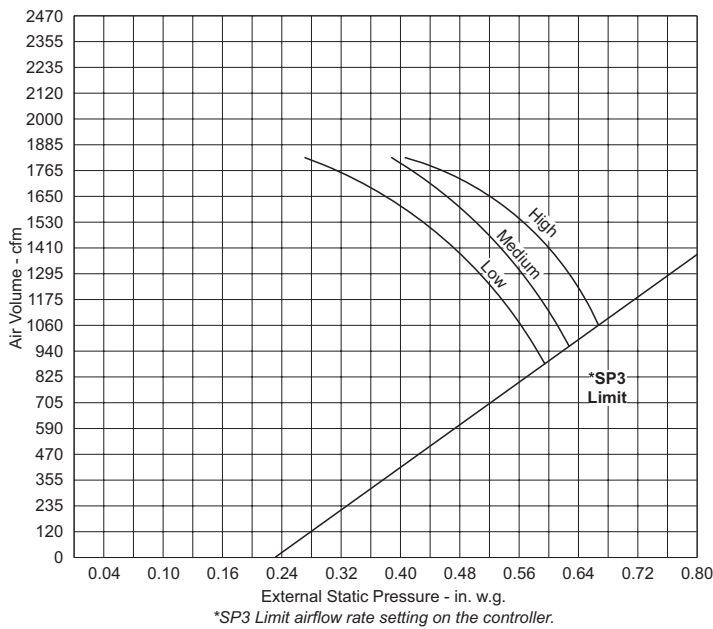
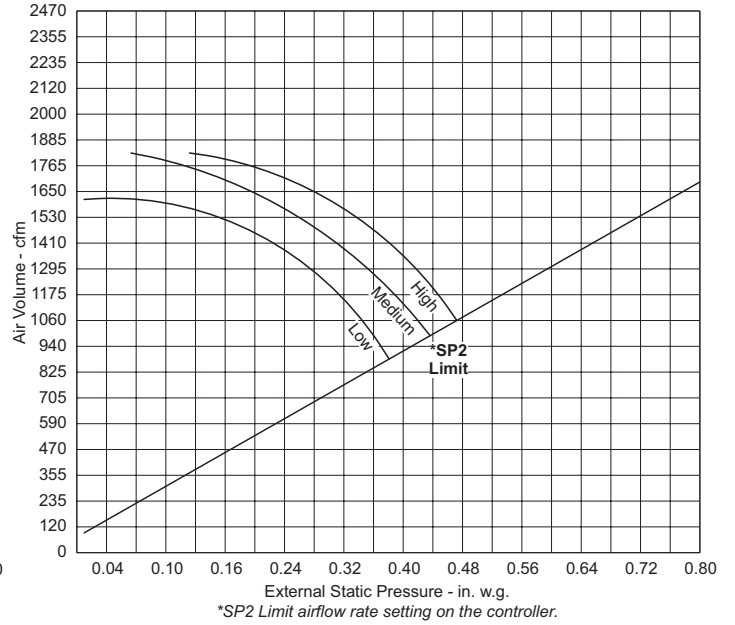
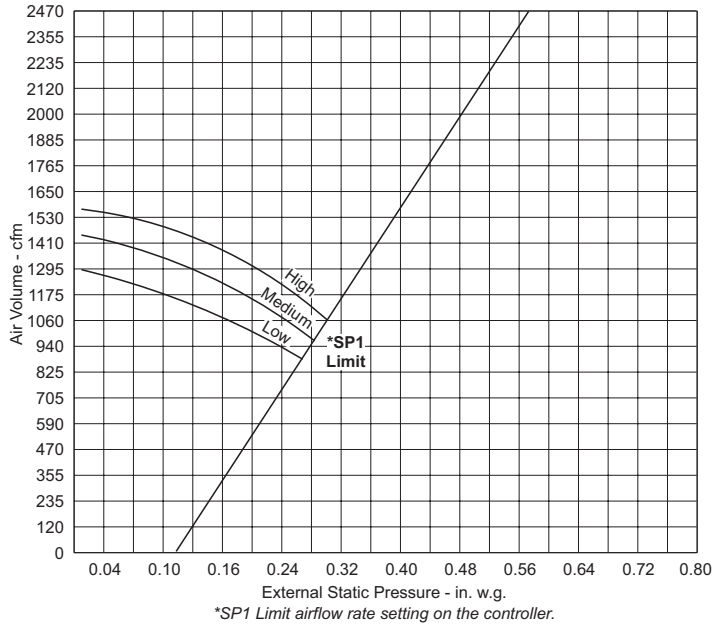

# DIMENSIONS

**MMDB009S4 | MMDB012S4 | MMDB018S4 | MMDB024S4 | MMDB036S4 | MMDB048S4**

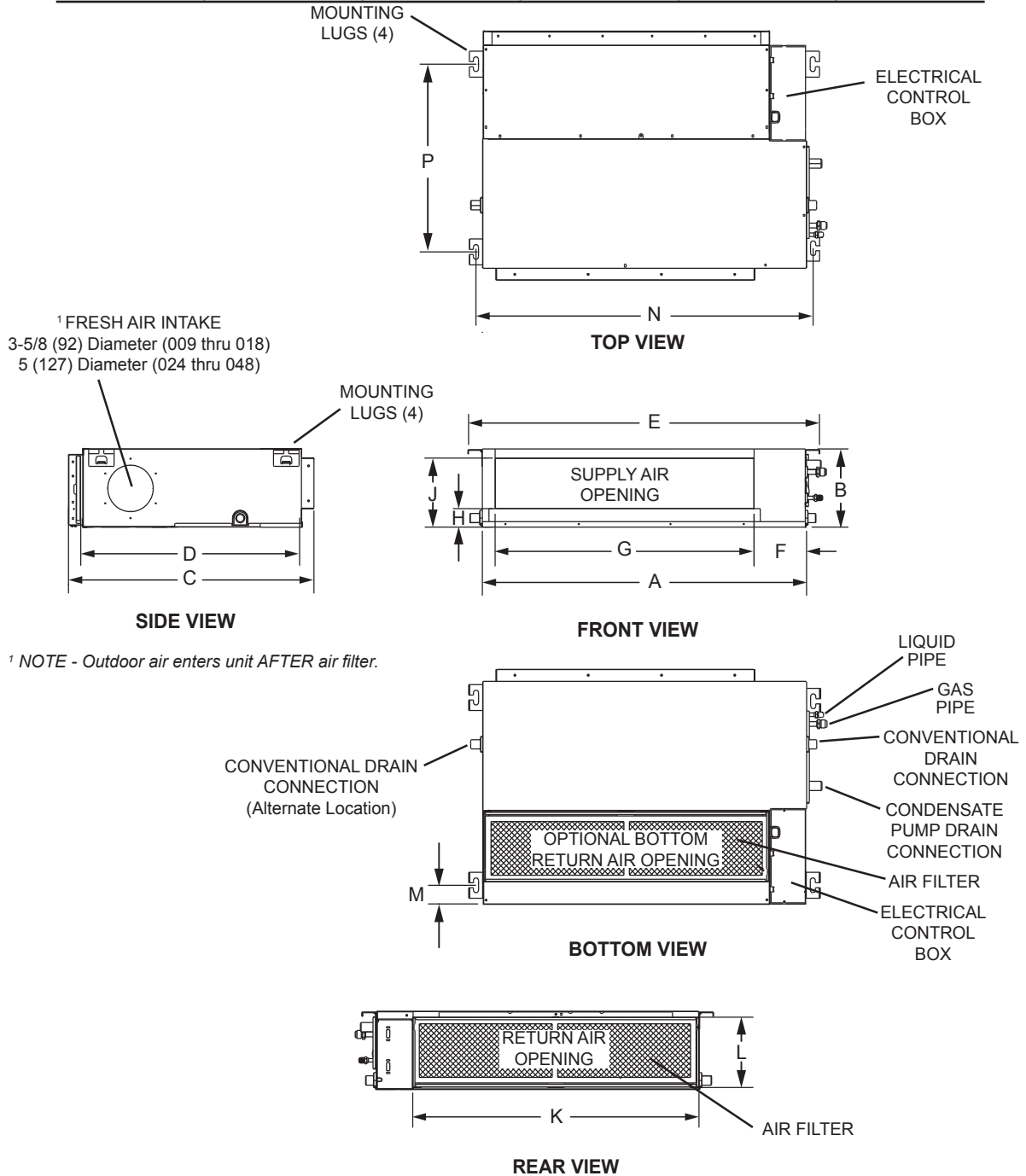

<sup>1</sup> NOTE - Outdoor air enters unit AFTER air filter.

Size	A		B		C		D		E		F		G		H	
	in.	mm	in.	mm	in.	mm	in.	mm	in.	mm	in.	mm	in.	mm	in.	mm
009 thru 012	27-5/8	702	7-7/8	200	19-7/8	505	17-3/4	451	30-3/4	781	5-3/8	137	21-1/8	537	1-1/8	29
018	34-5/8	879	8-1/4	210	26-1/2	673	23-5/8	600	37-7/8	962	5-1/2	140	27-3/4	705	2	51
024	43-1/4	1099	9-3/4	248	30-1/2	775	27-1/2	699	46-1/2	1181	5-1/2	140	36-1/2	927	2	51
036	53-1/2	1359	9-3/4	249	30-1/2	775	27-1/2	699	56-3/4	1441	5-1/2	140	46-3/4	1187	2	51
048	47-1/4	1200	11-7/8	302	34-3/8	873	31-1/2	800	50-1/2	1283	4-7/8	124	41-1/8	1045	2	51

  

Size	J		K		L		M		N		P	
	in.	mm	in.	mm	in.	mm	in.	mm	in.	mm	in.	mm
009 thru 012	6	152	23-5/8	600	7-3/8	187	2	51	29-1/8	740	14-1/8	359
018	5-3/8	137	30-3/4	781	7-1/2	191	1-5/8	41	36-1/4	921	20	508
024	6-7/8	175	39-3/8	1000	9	229	1/4	6	44-7/8	1140	23-1/2	597
036	6-7/8	175	49-5/8	1260	9	229	1/4	6	55-1/8	1400	23-1/2	597
048	9	229	43-3/8	1102	11	279	1/4	6	48-7/8	1241	27-1/2	699

# INSTALLATION CLEARANCES

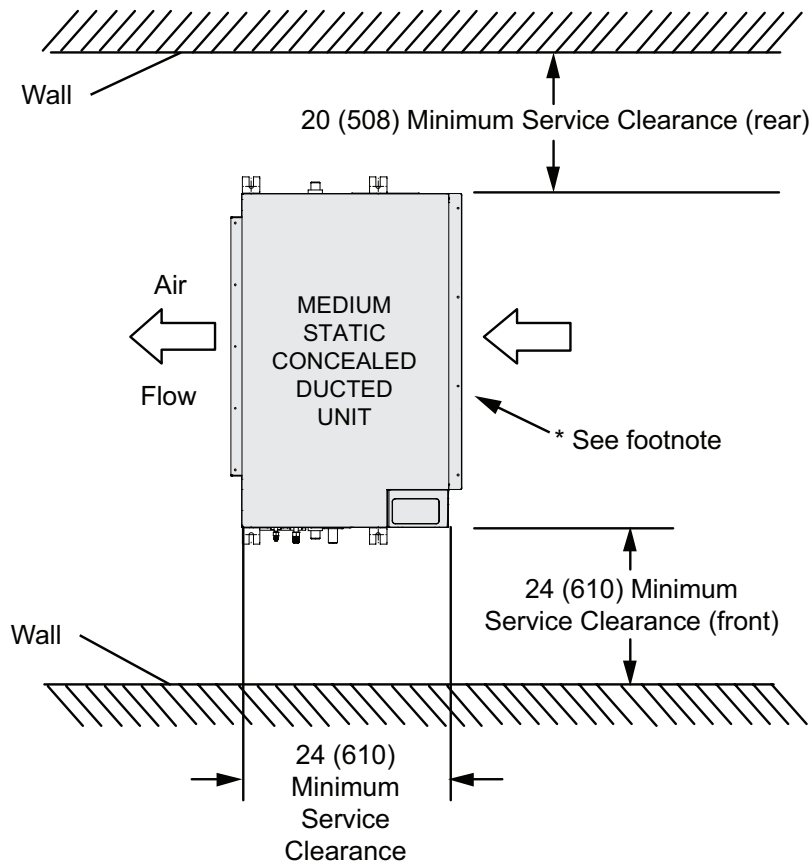

**TOP VIEW**

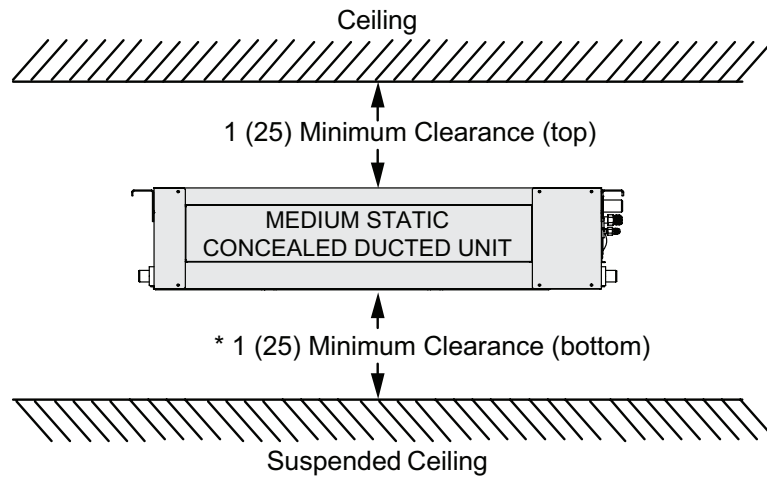

**\* NOTE - Bottom unit clearance can be 1 inch (25 mm), but allow 12 inches for filter removal on end return air applications**

**FRONT VIEW**

## REVISIONS

Sections	Description of Change
Approvals and Warranty	Updated Warranty statement.



**HRAI**  
✓ MEMBER COMPANY



Visit us at [www.Lennox.com](http://www.Lennox.com)

For the latest technical information, [www.LennoxPros.com](http://www.LennoxPros.com)

Contact us at 1-800-9-LENNOX

NOTE - Due to Lennox' ongoing commitment to quality, Specifications, Ratings and Dimensions subject to change without notice and without incurring liability. Improper installation, adjustment, alteration, service or maintenance can cause property damage or personal injury. Installation and service must be performed by a qualified installer and servicing agency.

©2024 Lennox Industries, Inc.