



538072-01

AA

BB

CC

DD

01

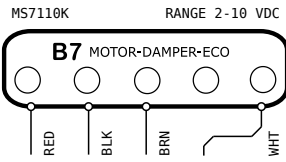

02

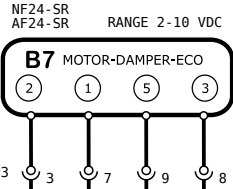

03

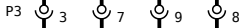

04

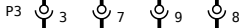

05

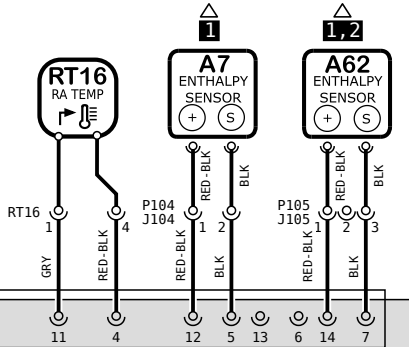

06

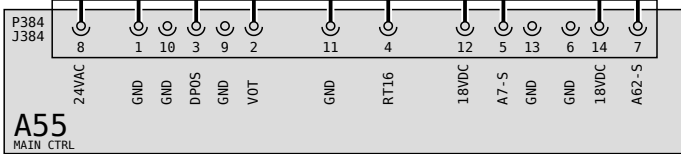

07

NOTES	
1	A7 AND A62 NOT USED FOR SENSIBLE TEMPERATURE CONTROL
2	FOR UNIT DIFFERENTIAL ENTHALPY CONTROL, ADD A62 RETURN AIR ENTHALPY SENSOR

08

KEY LIST		
LOCATION	COMPONENT DESCRIPTION	
CC05	A7	SENSOR, SOLID STATE ENTHALPY
AA06	A55	CONTROL BOARD, MAIN
DD05	A62	SENSOR, ENTHALPY INDOOR
BB02	B7	MOTOR, DAMPER ECONOMIZER
CC05	RT16	SENSOR, RETURN AIR TEMP

09

10

Model: LC, LG, LH, LD, SC, SG Series Economizer & Motorized OAD

Voltage: All Voltages

Supersedes: N/A Form No: 538072-01 Rev: 2

© 2019

HTG SEC A	CLG SEC B	CLG SEC B3	ACCS SEC C	ACCS SEC D
-----------------	-----------------	------------------	------------------	------------------

WIRING DIAGRAM FLOW

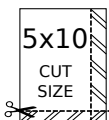

REV	EC NO.	DATE	BY	APVD	REVISION NOTE
---	CN-008594	10/15/2020	RV	MXR6	ORIGINATED AT PD&R CARROLLTON, TX
001	CN-010356B	03/24/2022	MXR6	JAL21	UPDATED APPLICABLE MODEL NUMBERS.
002	CN-012457P	03/06/2024	AXL	AAH	A) ADDED SC, SG TO MODELS



538072-01

AA

BB

CC

DD

01

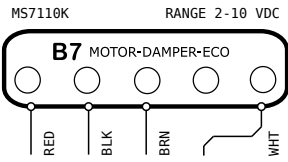

02

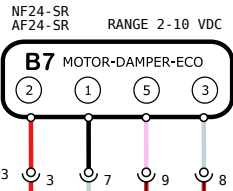

03

04

05

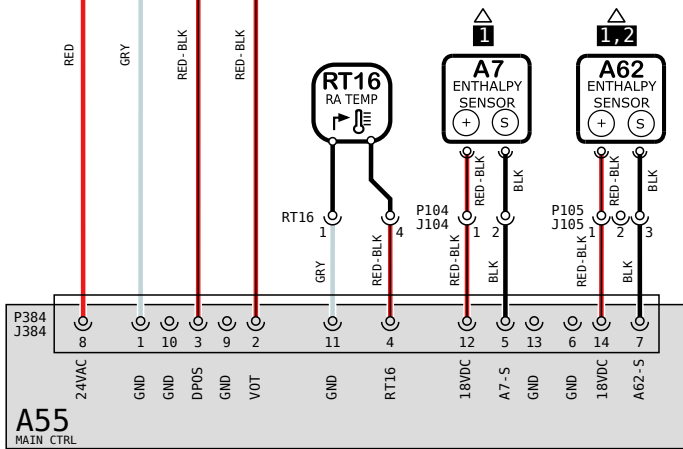

06

07

NOTES	
1	A7 AND A62 NOT USED FOR SENSIBLE TEMPERATURE CONTROL
2	FOR UNIT DIFFERENTIAL ENTHALPY CONTROL, ADD A62 RETURN AIR ENTHALPY SENSOR

08

KEY LIST	
LOCATION	COMPONENT DESCRIPTION
CC05	A7 SENSOR, SOLID STATE ENTHALPY
AA06	A55 CONTROL BOARD, MAIN
DD05	A62 SENSOR, ENTHALPY INDOOR
BB02	B7 MOTOR, DAMPER ECONOMIZER
CC05	RT16 SENSOR, RETURN AIR TEMP

09

10

Model: LC, LG, LH, LD, SC, SG Series Economizer & Motorized OAD  
 Voltage: All Voltages  
 Supersedes: N/A

© 2019

HTG SEC A	CLG SEC B	CLG SEC B3	ACCS SEC C	ACCS SEC D
-----------------	-----------------	------------------	------------------	------------------

WIRING DIAGRAM FLOW

Form No: 538072-01 Rev: 2

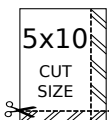

REV	EC NO.	DATE	BY	APVD	REVISION NOTE
---	CN-008594	10/15/2020	RV	MXR6	ORIGINATED AT PD&R CARROLLTON, TX
001	CN-010356B	03/24/2022	MXR6	JAL21	UPDATED APPLICABLE MODEL NUMBERS.
002	CN-012457P	03/06/2024	AXL	AAH	A) ADDED SC, SG TO MODELS